

User Guide

NTC-6200 Series – 3G M2M Router / Plus



Copyright

Copyright© 2016 NetComm Wireless Limited. All rights reserved.

The information contained herein is proprietary to NetComm Wireless. No part of this document may be translated, transcribed, reproduced, in any form, or by any means without prior written consent of NetComm Wireless.



Note: This document is subject to change without notice.

Save our environment

When this equipment has reached the end of its useful life, it must be taken to a recycling centre and processed separately from domestic waste.

The cardboard box, the plastic contained in the packaging, and the parts that make up this device can be recycled in accordance with regionally established regulations. Never dispose of this electronic equipment along with your household waste. You may be subject to penalties or sanctions under the law. Instead, ask for disposal instructions from your municipal government.

Please be responsible and protect our environment.

This manual covers the following products:

NetComm Wireless NTC-6200-02

NetComm Wireless NTC-6200-12

NetComm Wireless NTC-6200-13

DOCUMENT VERSION	DATE
1.0 – Initial document release	20/12/2013
1.1 – Updated GPS section with NMEA support information, Added Appendix G: Inputs / Outputs.	24/01/2014
1.2 – Updated LED signal strength table	03/03/2014
1.3 – Updated Wake settings description	12/05/2014
1.4 – Updated Appendix F: Serial port wiring	21/05/2014
1.5 – Added description of Transparent bridging	10/07/2014
1.6 – Added Event notification, Email client, Legacy data managers descriptions. Updated “Manually configuring a connection profile” section to include preferred IP address selection. Removed Mobile Station Based Assisted GPS description.	15/09/2014
1.7 – Added new Endpoint types	02/12/2014
1.8 – Updated for 2.0.24.3 firmware. Updated OpenVPN and System log sections. Added new event notification event types for IO. Added Lightweight M2M section. Added new SMS commands. Added instructions for SSH key generation. HTTPS key management renamed to Server certificate. Other minor corrections.	01/04/2015
1.9 – Added TCP connect-on-demand endpoint description.	05/06/2015
2.0 – Updated for v2.0.27.1 firmware. Updated IPSec configuration, port forwarding configuration, WAN failover, WAN configuration and Lightweight M2M sections. Added TCP connect-on-demand endpoint.	26/06/2015
2.1 – Updated TCP server and TCP client endpoint descriptions.	23/09/2015
2.2 – Updated PPTP Client configuration.	16/02/2016
2.3 – Updated Ethernet LAN/WAN section. Added supported altitude range to Safety and product care section.	08/06/2016

Table 1 - Document Revision History

Table of contents

Overview	6
Introduction	6
Target audience.....	6
Prerequisites	6
Notation	6
Product introduction.....	7
Product overview	7
Package contents.....	7
Product features.....	8
Physical dimensions and indicators	9
Physical dimensions	9
LED indicators	10
Signal strength LEDs	11
LED update interval.....	11
Ethernet port LED indicators	11
Interfaces	12
NTC-6200-02 and NTC-6200-12 models.....	12
NTC-6200-13 models.....	13
Placement of the router.....	14
Mounting options.....	14
Mounted flat against the wall.....	14
DIN rail mounting bracket.....	14
Wall mounted via DIN rail bracket.....	15
DIN rail mount	15
Pole mount using DIN rail bracket	16
Desk mount.....	16
Installation and configuration of the NTC-6200 Series router.....	17
Powering the router	17
DC power via 6-pin or 2-pin connector.....	17
DC power via field terminated power source.....	17
Viewing power source information	18
Power consumption.....	19
Average power consumption figures.....	19
Installing the router	19
Advanced configuration	20
Status	21
Networking.....	24
Data Connection.....	24
Connecting to the mobile broadband network	25
Manually configuring a connection profile.....	25
Confirming a successful connection	27
Transparently bridging the mobile broadband connection via PPPoE.....	28
Connect on demand.....	29
Configuring Connect on demand.....	29
Setting the router to dial a connection when traffic is detected on specific ports	30
Excluding certain packet types from triggering the connection to dial	30
Excluding certain application types from triggering the connection to dial	30
Setting timers for connection and disconnection.....	31
Verbose mode.....	31
Manually connecting/disconnecting.....	32
SMS Wake up	32
Operator Settings	33
Operator settings.....	33
SIM security settings.....	34
Unlocking a PIN locked SIM	34
Enabling/Disabling SIM PIN protection.....	36
Changing the SIM PIN code.....	37
Unlocking a PUK locked SIM.....	38
LAN	39
LAN configuration.....	39
DHCP	40
Ethernet LAN/WAN.....	43
Interface assignment.....	43
WAN configuration.....	44

WAN failover.....	45
Link monitor	46
Ping monitor.....	46
Routing	49
Static	49
RIP.....	51
Redundancy (VRRP) configuration.....	52
Port Forwarding.....	53
DMZ.....	55
Router firewall.....	56
MAC / IP / Port filtering	57
Creating a MAC / IP / Port filtering rule	57
VPN.....	59
IPSec	59
Configuring an IPSec VPN.....	59
OpenVPN.....	62
Configuring an Open VPN server.....	62
OpenVPN Server	62
Configuring an OpenVPN Client.....	65
Configuring an OpenVPN P2P Connection	67
PPTP-Client.....	68
Configuring the PPTP Client	68
GRE tunnelling.....	70
Configuring GRE tunnelling	70
Services.....	72
Dynamic DNS.....	72
Network time (NTP).....	73
Configuring Timezone settings	73
Configuring NTP settings	73
Data stream manager	74
Endpoints.....	74
Streams	83
Data stream applications.....	85
Legacy data managers	86
Modem emulator	86
PADD.....	88
Remote management	89
SNMP	89
TR-069.....	91
OMA Lightweight M2M configuration.....	93
GPS.....	95
NMEA support.....	95
GPS configuration.....	95
Mobile Station Based Assisted GPS configuration.....	96
Odometer	97
IO configuration	98
Event notification	100
Notification configuration.....	100
Destination configuration.....	105
Email settings	106
SMS messaging	107
Setup.....	107
SMS forwarding configuration	108
Redirect to mobile	108
Redirect to TCP / UDP server address	108
New message	109
Inbox / Sent Items	110
Diagnostics	111
SMS diagnostics and command execution configuration.....	111
White List for diagnostic or execution SMS	113
Sending an SMS Diagnostic Command.....	114
Types of SMS diagnostic commands	114
SMS acknowledgment replies	114
SMS command format.....	115
List of basic commands	116
List of get/set commands	117
List of basic RDB variables.....	119
Network scan and manual network selection by SMS	119

SMS diagnostics examples	121
System	123
Log	123
System log	123
IPSec log.....	123
Event notification log	124
System log settings	125
System configuration	127
Settings backup and restore	127
Upload	128
Updating the Firmware.....	128
Package manager.....	130
Administration	131
Administration settings.....	131
Server certificate	133
SSH key management	136
LED operation mode.....	138
Watchdogs.....	139
Configuring Periodic Ping settings	141
Disabling the Periodic Ping reset function	141
Configuring a Periodic reboot.....	141
Power management	142
Ignition pin.....	142
Sleep settings.....	143
Wake settings.....	144
Reboot.....	146
Logging out.....	146
Appendix A: Tables.....	147
Appendix B: Default Settings	149
Restoring factory default settings	150
Using the web-based user interface	150
Using the reset button on the interface panel of the router.....	150
Appendix C: Recovery mode	151
Accessing recovery mode.....	151
Status	152
Log.....	152
Application Installer.....	153
Settings.....	153
Reboot.....	153
Appendix D: HTTPS - Uploading a self-signed certificate.....	154
Appendix E: RJ-45 connector	156
Appendix F: Serial port wiring.....	157
Appendix G: Inputs/Outputs	158
Overview	158
Hardware Interface	158
Wiring Examples.....	159
Open Collector Output driving a relay	159
Logic level Output.....	159
LED Output	159
Digital inputs.....	160
NAMUR Sensor	160
Analogue Sensor with Voltage output	161
Analogue Sensor with 4 to 20mA output	161
Analogue Sensor with Thermistor	161
System Example –Solar powered Router with battery backup	162
Appendix H: Obtaining a list of RDB variables.....	163
Safety and product care.....	164
Vietnam Certification	168
Product Warranty.....	169

Overview

Introduction



This document provides you all the information you need to set up, configure and use the NetComm Wireless NTC-6200 Series router.

Target audience

This document is intended for system integrators or experienced hardware installers who understand telecommunications terminology and concepts.

Prerequisites

Before continuing with the installation of your NTC-6200 Series router, please confirm that have the following:

-  A device with a working Ethernet network adapter.
-  A web browser such as Internet Explorer®, Mozilla Firefox® or Google Chrome™.
-  A flathead screwdriver if field terminated power is required.

Notation

The following symbols are used in this user guide:



The following note requires attention.



The following note provides a warning.



The following note provides useful information.

Product introduction

Product overview

- Penta-band 3G with quad-band 2G auto-fallback
- HSPA+ up to 14.4 Mbps DL
- RS232/RS422/RS485 Port and USB 2.0 OTG port
- Built in GPS supporting an active GPS Antenna via external SMA connector (NTC-6200-02 and NTC-6200-12 only)
- External antenna connectors (Main & Aux) for 3G
- Three multi-purpose I/O ports (NTC-6200-02 and NTC-6200-12 only)
- One dedicated ignition input (NTC-6200-02 and NTC-6200-12 only)
- Intelligent, Tri-Colour LED display for clear, easy to read modem status information
- Extensive device management with support for TR-069, Web GUI and full feature management with SMS
- Flexible mounting suitable for in-home use or industrial applications with built-in wall mount and DIN rail mounting options

Package contents

The NetComm Wireless NTC-6200 Series router package consists of:

- 1 x NTC-6200 Series router
- 2 x 3G antennas
- 1 x 1.5m yellow Ethernet cable 8P8C
- 1 x DIN rail mounting bracket
- 1 x six-way terminal block
- 1 x SIM card tray cover
- 1 x Torx screw for SIM card tray cover
- 1 x Quick start guide

If any of these items are missing or damaged, please contact NetComm Wireless Support immediately. The NetComm Wireless Support website can be found at: <http://support.netcommwireless.com>.

Product features

The NetComm Wireless NTC-6200 Series router is an M2M device designed by NetComm Wireless to address the rapid growth in M2M deployments. It has been designed to provide state-of-the-art features and versatility at an affordable price. Compatible with networks worldwide, the NTC-6200 Series router can be managed remotely even when it does not have an Internet connection via the use of SMS diagnostics and commands.

The NTC-6200 Series router includes many features such as Connect on demand which provides a means to seamlessly connect or disconnect the mobile broadband connection to conserve usage; TR-069 support for easy management of a group of NTC-6200 Series routers; and the ability to function as an SSH server to secure communications. Additionally, the open management system allows you to expand the feature set by producing your own custom software applications.

The NetComm Wireless NTC-6200 Series router meets the global demand for a reliable and cost-effective M2M device that successfully caters to mass deployment across businesses.

Physical dimensions and indicators

Physical dimensions

Below is a list of the physical dimensions of the NTC-6200 Series router.



Figure 1 – NTC-6200 Series router Dimensions

NTC-6200 SERIES ROUTER (WITHOUT EXTERNAL ANTENNAS ATTACHED)	
Length	143 mm
Depth	107 mm
Height	34 mm
Weight	221g

Table 2 - Device Dimensions

LED indicators

The NTC-6200 Series router uses 8 LEDs to display the current system and connection status.

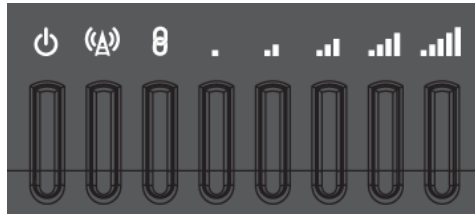

Figure 2 - NTC-6200 Series router LED Indicators

























LED ICON	NAME	COLOUR	STATE	DESCRIPTION
	Power		Off	Power off
			Double flash	Powering up
			On	Power on
			On	Power on in recovery mode
			Slow flashing	Hardware error
	Network		On	Connected via WWAN
			Blinking ¹	Traffic via WWAN
			Slow flashing	Connecting PDP
			On	Registered network
			Slow flashing	Registering network
			Slow flashing	SIM PIN locked
			Fast flashing	SIM PUK locked
			On	Can't connect
	GPS ² / Customizable LED Indicator		Off	GPS function disabled
			On	GPS function is enabled but no satellite is detected.
			Slow flashing	Satellite detected, acquiring location.
			On	Satellite detected, location acquired.
	Signal strength		On	3G
			On	2G GPRS
			On	GSM only (no GPRS)

Table 3 - LED Indicators

¹ The term "blinking" means that the LED may pulse, with the intervals that the LED is on and off not being equal. The term "flashing" means that the LED turns on and off at equal intervals.

² GPS not available on NTC-6200-03 and NTC-6200-13.

Signal strength LEDs

The following table lists the signal strength range corresponding with the number of lit signal strength LEDs.

NUMBER OF LIT LEDs	SIGNAL STRENGTH
All LEDs unlit	< -109 dBm
1	-109 dBm to -102dBm
2	-101 dBm to -92 dBm
3	-91 dBm to -86 dBm
4	-85 dBm to -78 dBm
5	≥ -77 dBm

Table 4 - Signal strength LED descriptions

LED update interval

The signal strength LEDs update within a few seconds with a rolling average signal strength reading. When selecting a location for the router or connecting and positioning an external antenna, please allow up to 20 seconds for the signal strength LEDs to update before repositioning.

Ethernet port LED indicators

The Ethernet port of the NTC-6200 Series router has two LED indicators on it.

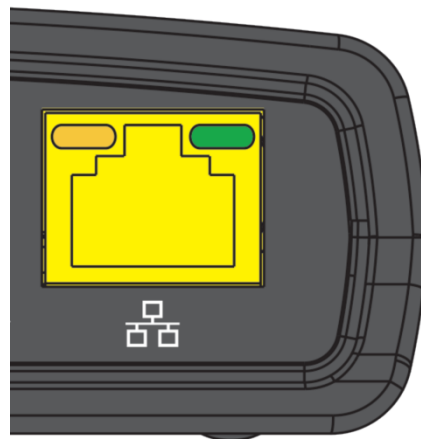

Figure 3 - Ethernet port LED indicators

The table below describes the statuses of each light and their meanings.

LED	STATUS	DESCRIPTION
Green	On	There is a valid network link.
	Blinking	There is activity on the network link.
	Off	No valid network link detected.
Amber	On	The Ethernet port is operating at a speed of 100Mbps.
	Off	The Ethernet port is operating at a speed of 10Mbps or no Ethernet cable is connected.

Table 5 - Ethernet port LED indicators description

Interfaces

NTC-6200-02 and NTC-6200-12 models

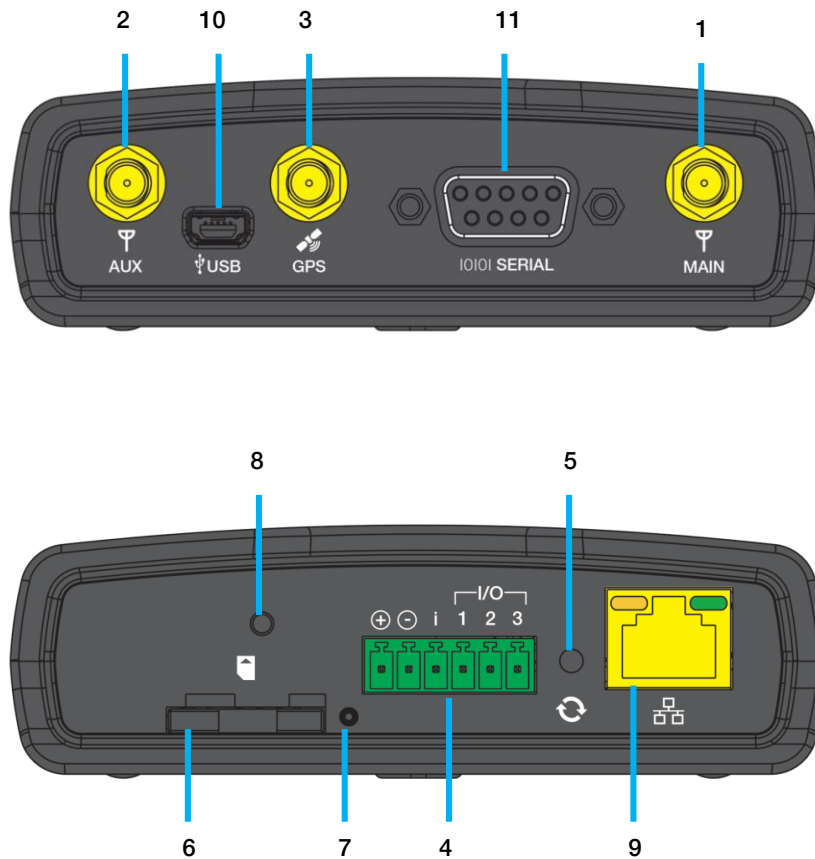

Figure 4 - Interfaces - NTC-6200-02 and NTC-6200-12 models

NO.	ITEM	DESCRIPTION
1	Main antenna socket	SMA female connector for main antenna.
2	Aux antenna socket	SMA female connector for auxiliary antenna (receive diversity).
3	GPS antenna socket	SMA female connector for an active GPS antenna.
4	Six-way terminal block connector	Connect power source, ignition and I/O wires here. Power, ignition and I/O wires may be terminated on the supplied terminal block and connected to a power source. Refer to the diagram and table under the Installation section for correct wiring of the terminal block. Operates in the 8-40V DC range.
5	Reset button	Press and hold for less than 5 seconds to reboot to normal mode. Press and hold for 5 to 15 seconds to reboot to recovery mode. Press and hold for 15 to 20 seconds to reset the router to factory default settings.
6	SIM card slot	Insert SIM card here.
7	SIM tray eject button	Press to eject the SIM tray
8	Torx screw hole	If desired, place the SIM tray cover over the SIM card slot and fix it to the router's body using the included Torx screw.
9	RJ45 Ethernet port	Connect one or several devices via a network switch here.
10	Mini USB 2.0 OTG port	Provides connectivity for optional external storage or a USB Ethernet dongle. Supplies up to 0.5A to connected device.
11	Serial port	Female DE-9 port supporting 9-wire RS-232, RS-485 or RS-422 (software selectable).

Table 6 - Interfaces - NTC-6200-02 and NTC-6200-12 models

NTC-6200-13 models

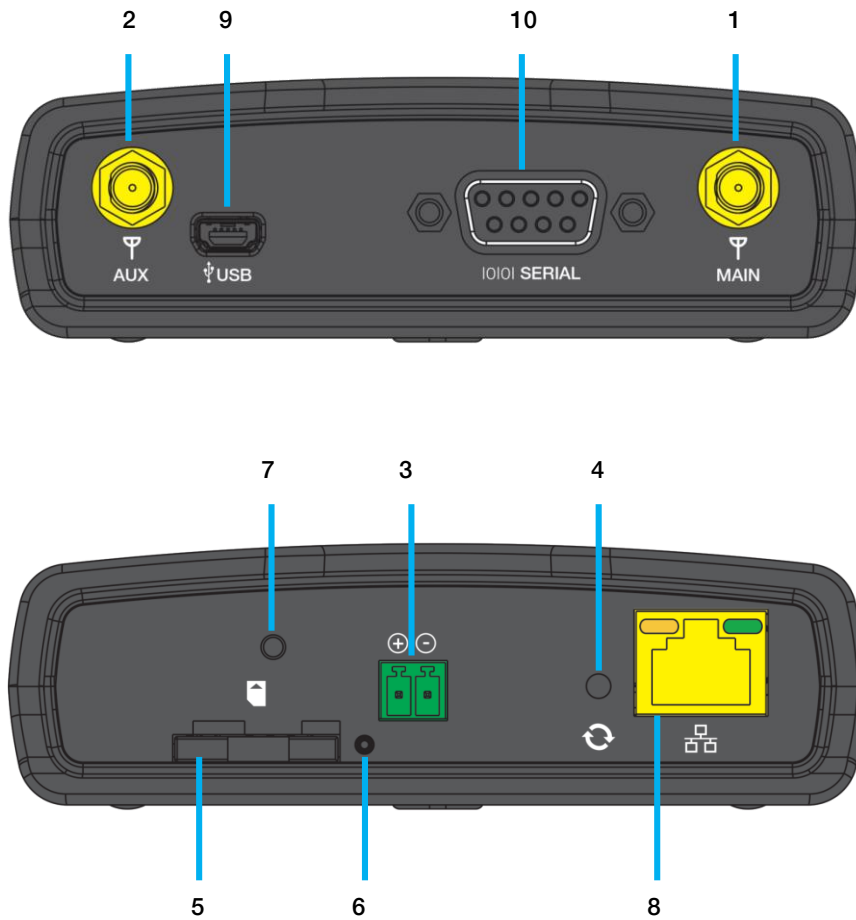

Figure 5 - Interfaces NTC-6200-13 model

NO.	ITEM	DESCRIPTION
1	Main antenna socket	SMA female connector for main antenna.
2	Aux antenna socket	SMA female connector for auxiliary antenna (receive diversity).
3	Two-way terminal block connector	Connect power source wires here. Power wires may be terminated on the supplied terminal block and connected to a power source. Refer to the diagram and table under the Installation section for correct wiring of the terminal block. Operates in the 8-40V DC range.
4	Reset button	Press and hold for less than 5 seconds to reboot to normal mode. Press and hold for 5 to 15 seconds to reboot to recovery mode. Press and hold for 15 to 20 seconds to reset the router to factory default settings.
5	SIM card slot	Insert SIM card here.
6	SIM tray eject button	Press to eject the SIM tray
7	Torx screw hole	If desired, place the SIM tray cover over the SIM card slot and fix it to the router's body using the included Torx screw.
8	RJ45 Ethernet port	Connect one or several devices via a network switch here.
9	Mini USB 2.0 OTG port	Provides connectivity for optional external storage or a USB Ethernet dongle. Supplies up to 0.5A to connected device.
10	Serial port	Female DE-9 port supporting 9-wire RS-232, RS-485 or RS-422 (software selectable).

Table 7 - Interfaces NTC-6200-03 and NTC-6200-13 models

Placement of the router

The two external high-performance antennas supplied with the router are designed to provide optimum signal strength in a wide range of environments. If you find the signal strength is weak, try adjusting the orientation of the antennas. If you are unable to get an acceptable signal, try moving the router to a different place or mounting it differently.



Note: When selecting a location for the router, allow at least 20 seconds for the signal strength LEDs to update before trying a different location.

Mounting options

The NTC-6200 Series router can be quickly and easily mounted in a variety of locations.

Mounted flat against the wall

When mounted flat against the wall, the NTC-6200 Series router has a slimline form factor. Use appropriately sized screws in the mounting holes provided on the base of the unit.

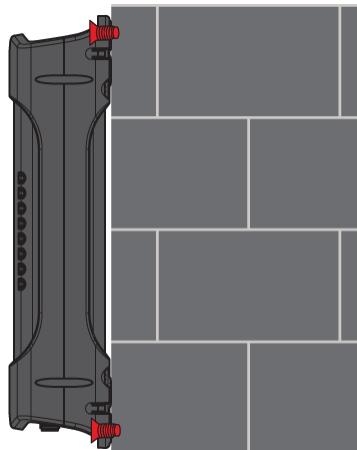

Figure 6 - Wall mount - Flat against the wall

DIN rail mounting bracket

V Bend allows you to snap the DIN bracket onto the middle of a DIN rail rather than sliding it onto the end.

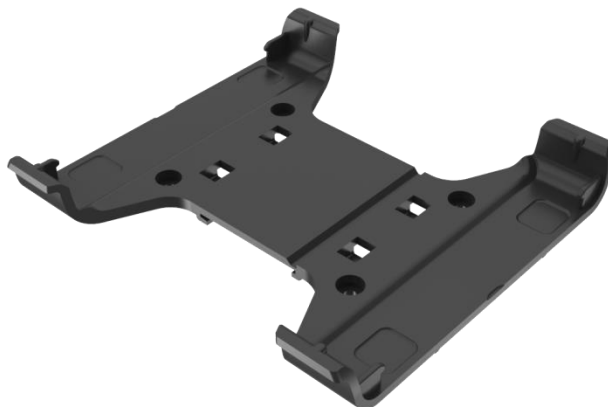

Figure 7 - NTC-6200 Series mounting bracket

Wall mounted via DIN rail bracket

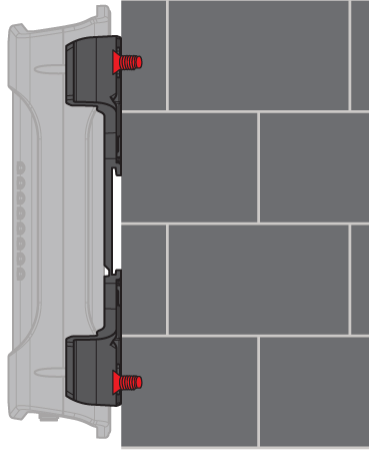

Figure 8 - Wall mounted via DIN rail bracket

DIN rail mount

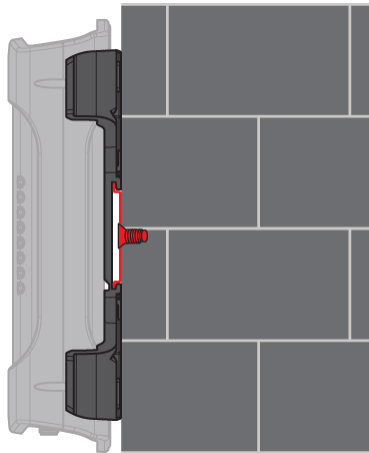

Figure 9 - DIN rail mount

Pole mount using DIN rail bracket

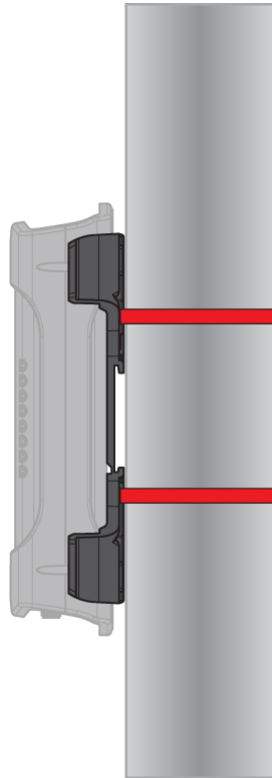

Figure 10 - Pole mount using DIN rail bracket

Desk mount

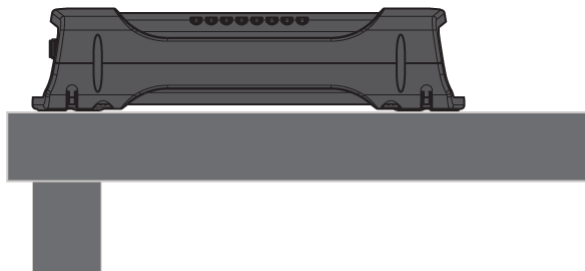

Figure 11 - Desk mount

Installation and configuration of the NTC-6200 Series router

Powering the router

The NTC-6200 Series router can be powered in one of two ways:

1. DC power input via 6-pin or 2-pin connector (8-40V DC)
2. DC power input via field terminated power source (8-40V DC)

The green power LED on the router lights up when a power source is connected.

DC power via 6-pin or 2-pin connector

The DC input jack can accept power from a separately sold DC power supply. Both a standard temperature range DC power supply and an extended temperature range DC power supply are available to purchase as accessories.

To supply the router with DC Power via the 6-pin or 2-pin connector, remove the attached green terminal block from your router and connect the external DC power supply to the router's green DC power jack.

DC power via field terminated power source

If an existing 8-40V DC power supply is available, you can insert the wires into the supplied terminal block to power your router. Use a flathead screwdriver to tighten the terminal block screws and secure the power wires, making sure the polarity of the wires are correctly matched for your particular unit, as illustrated below.

NTC-6200-02 and NTC-6200-12

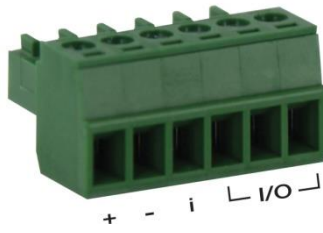

Figure 12 – Locking Six-way Power Terminal Block

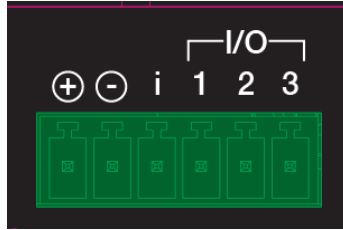

Figure 13 – Terminal block connector

TERMINAL	DESCRIPTION
+	Positive wire for power.
-	Ground wire.
i	Dedicated terminal for ignition detection.
I/O	Three terminals used for input/output detection (refer to the IO configuration section for more information).

Table 8 - Locking power block pin outs

NTC-6200-13



Figure 14 – Locking Two-way Power Terminal Block

PIN	SIGNAL	DESCRIPTION
+	V+	Voltage +
-	V-	Ground

Table 9 - Locking power block pin outs

Viewing power source information

You can view the current power input mode in the **Advanced status** section of the device's web user interface. This is useful for remotely monitoring the device. You can also use the Software Development Kit to access this information for advanced purposes (e.g. configuring SMS alerts to inform you of the power status of the router).

To view the router's power source information, log in to the router and expand the **Advanced status** box on the status page. See the [Status](#) section of this manual for more information on the status page.

Power consumption

To assist with power consumption planning, the following table summarises average power consumption during the various states of the NTC-6200 Series router under normal usage conditions. It's important to note that this table serves as an indication only as the power consumed by the device is affected by many variables including signal strength, network type, and network activity.

Average power consumption figures

STATE	POWER CONSUMPTION
Powering up, inrush power	6.0W
Powered on, idle and connected to packet data	1.2W
Powered on, connected to packet data with average load	2.0W
Powered on, connected to packet data with heavy traffic	4.0W
Peak power draw at maximum 3G module transmission power	5.0W

Table 10 - Average power consumption figures

Installing the router

After you have mounted the router and connected a power source, follow these steps to complete the installation process.

1. Connect equipment that requires network access to the Ethernet port of your router. This may be your computer for advanced configuration purposes, or your end equipment which requires data access via the NTC-6200 Series router. You can connect one device directly, or several devices using a network switch.
If you're using PoE as the power source, you need to connect any devices via an available data Ethernet port on your PoE power source (be it a PoE network switch or PoE power injector).
2. Ensure the external power source is switched on and wait 2 minutes for your NTC-6200 Series router to start up. To check the status of your router, compare the LED indicators on the device with those listed in the [LED Indicators](#) section of this guide.

Advanced configuration

The NTC-6200 Series router comes with pre-configured settings that should suit most customers. For advanced configuration, log in to the web-based user interface of the router.

To log in to the web-based user interface:

1. Open a web browser (e.g. Internet Explorer, Firefox, Safari), type <http://192.168.1.1> into the address bar and press **Enter**. The web-based user interface log in screen is displayed.

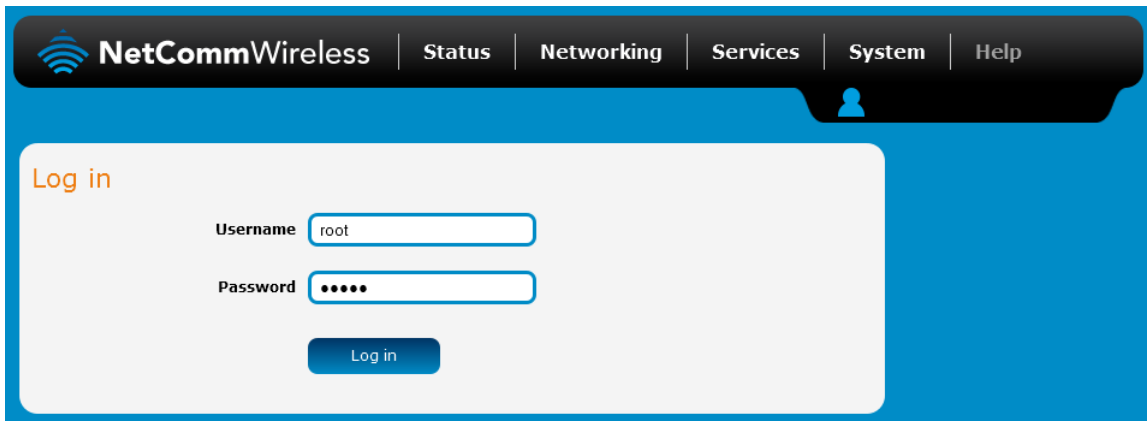

Figure 15 – Log in prompt for the web-based user interface

2. Enter the login username and password. If this is the first time you are logging in or you have not previously configured the password for the “root” or “admin” accounts, you can use one of the default account details to log in.

ROOT MANAGER ACCOUNT	
Username:	root
Password:	admin

Table 11 - Management account login details – Root manager

ADMIN MANAGER ACCOUNT	
Username:	admin
Password:	admin



Table 12 - Management account login details – Admin manager



Note: To access all features of the router, you must use the root manager account. For security reasons, we highly recommend that you change the passwords for the root and admin accounts upon initial installation. You can do so by navigating to the System and then Administration page.

The Status page is displayed when you have successfully logged in.

Status

The status page of the web interface provides system related information and is displayed when you log in to the NTC-6200 Series router management console. The status page shows System information, LAN details, Cellular connection status, Packet data connection status and Advanced status details. You can toggle the sections from view by clicking the  or  buttons to show or hide them. Extra status boxes will appear as additional software features are enabled (e.g. VPN connectivity).

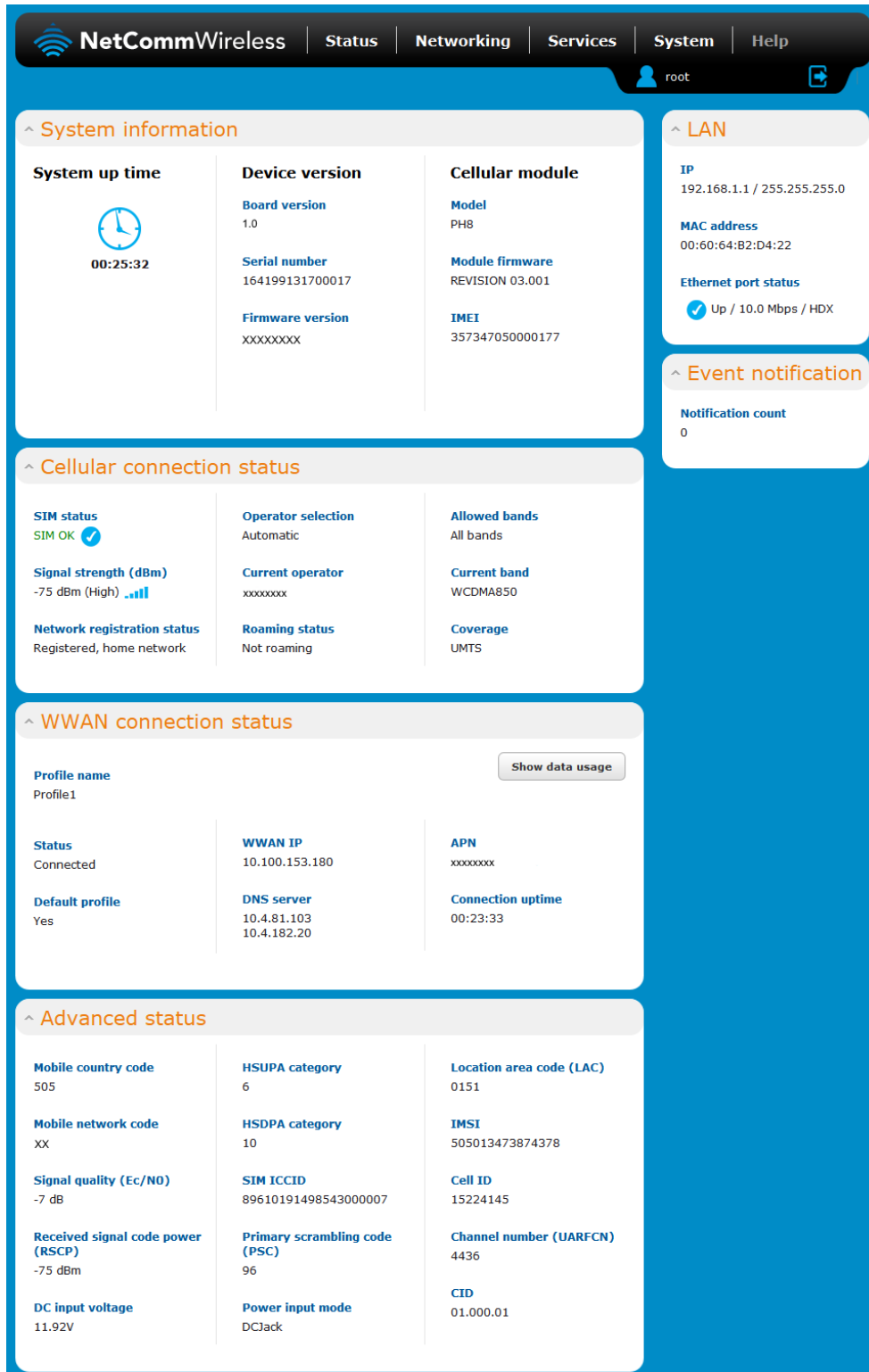

The screenshot shows the NetCommWireless web interface with the following sections:

- System information**
 - System up time:** 00:25:32
 - Device version:** Board version 1.0, Serial number 164199131700017, Firmware version XXXXXXXX
 - Cellular module:** Model PH8, Module firmware REVISION 03.001, IMEI 357347050000177
- LAN**
 - IP:** 192.168.1.1 / 255.255.255.0
 - MAC address:** 00:60:64:B2:D4:22
 - Ethernet port status:** Up / 10.0 Mbps / HDX
- Event notification**
 - Notification count:** 0
- Cellular connection status**
 - SIM status:** SIM OK
 - Operator selection:** Automatic
 - Allowed bands:** All bands
 - Signal strength (dBm):** -75 dBm (High)
 - Current operator:** xxxxxxxx
 - Current band:** WCDMA850
 - Network registration status:** Registered, home network
 - Roaming status:** Not roaming
 - Coverage:** UMTS
- WWAN connection status**
 - Profile name:** Profile1 (with Show data usage button)
 - Status:** Connected
 - WWAN IP:** 10.100.153.180
 - APN:** xxxxxxxx
 - Default profile:** Yes
 - DNS server:** 10.4.81.103, 10.4.182.20
 - Connection uptime:** 00:23:33
- Advanced status**
 - Mobile country code:** 505
 - HSUPA category:** 6
 - Location area code (LAC):** 0151
 - Mobile network code:** XX
 - HSDPA category:** 10
 - IMSI:** 505013473874378
 - Signal quality (Ec/NO):** -7 dB
 - SIM ICCID:** 89610191498543000007
 - Cell ID:** 15224145
 - Received signal code power (RSCP):** -75 dBm
 - Primary scrambling code (PSC):** 96
 - Channel number (UARFCN):** 4436
 - DC input voltage:** 11.92V
 - Power input mode:** DCJack
 - CID:** 01.000.01

Figure 16 - The Status page

ITEM	DEFINITION
System information	
System up time	The current uptime of the router.
Board version	The hardware version of the router.
Serial Number	The serial number of the router.
Firmware version	The firmware version of the router
Model	The type of phone module and the firmware version of the module.
Module firmware	The firmware revision of the phone module.
IMEI	The International Mobile Station Equipment Identity number used to uniquely identify a mobile device.
LAN	
IP	The IP address and subnet mask of the router.
MAC Address	The MAC address of the router.
Ethernet Port Status	Displays the current status of the Ethernet port and its operating speed.
Event notification	
Notification count	Displays the number of notifications sent using the Event notification feature.
Cellular connection status	
SIM Status	Displays the activation status of the router on the carrier network.
Signal strength (dBm)	The current signal strength measured in dBm
Network registration status	The status of the router's registration for the current network.
Operator selection	The mode used to select an operator network.
Current operator	The current operator network in use.
Roaming status	The roaming status of the router.
Allowed bands	The bands to which the router may connect.
Current band	The current band being used by the router.
Coverage	The type of mobile coverage being received by the router.
WWAN Connection Status	
Profile name	The name of the active profile.
Status	The connection status of the active profile.
Default profile	Indicates whether the current profile in use is the default profile.
WWAN IP	The IP address assigned by the mobile broadband carrier network.
DNS server	The primary and secondary DNS servers for the WWAN connection.
APN	The Access Point Name currently in use.
Connection uptime	The length of time of the current mobile connection session.
Advanced status	
Mobile country code	The Mobile Country Code (MCC) of the router.
Mobile network code	The Mobile Network Code (MNC) of the router.
Signal quality (Ec/N0)	A measurement of the portion of the received signal that is usable. This is the signal strength minus the signal noise level.
Received signal code power (RSCP)	The power level of the signal on the current connection's particular channel.
Power input mode	Displays where the power is currently being sourced from.
HSUPA category	Displays the HSUPA category (1-9) for the current uplink
HSDPA category	Displays the HSDPA category (1-8) for the current downlink.
SIM ICCID	The Integrated Circuit Card Identifier of the SIM card used with the router, a unique number up to 19 digits in length.
Primary scrambling code (PSC)	The Primary scrambling code for the current signal.
DC input voltage	Displays the current voltage of the power input source provided via the DC Input jack
Location area code (LAC)	The ID of the cell tower grouping the current signal is broadcasting from.
IMSI	The International mobile subscriber identity is a unique identifier of the user of a cellular network.
Cell ID	A unique code that identifies the base station from within the location area of the current mobile network signal.

Channel number (UARFCN)	The channel number of the current 3G/2G connection.
CID	Cellular configuration ID

Table 13 - Status page item details

Networking

The Networking section provides configuration options for Wireless WAN, LAN, Routing and VPN connectivity.

Data Connection

The data connection page allows you to configure and enable/disable the connection profile. To access this page, click on the **Networking** menu, and under the **Wireless WAN** menu, select the **Data connection** item.

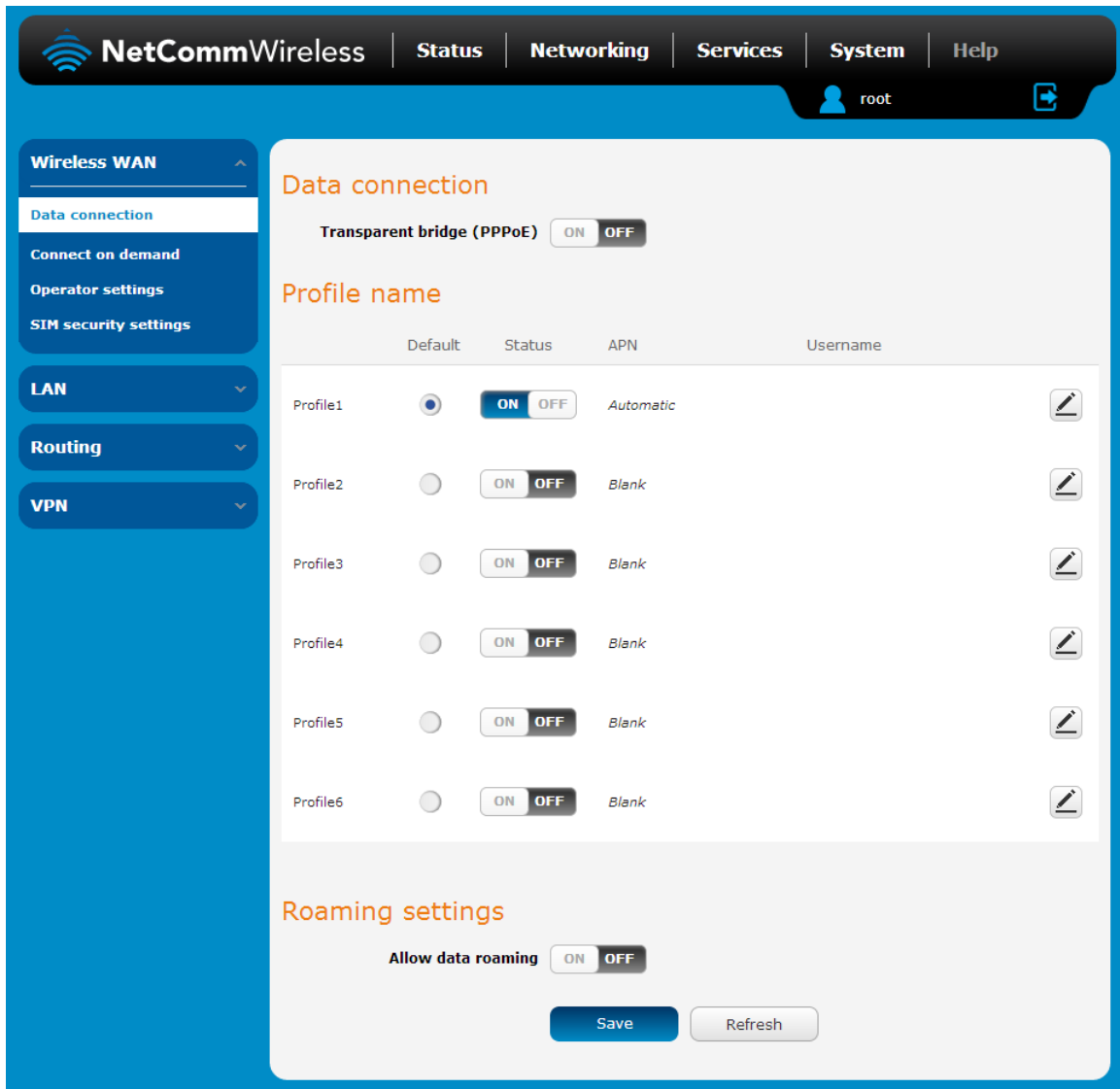

Figure 17 – Data connection settings

ITEM	DEFINITION
Data connection	
Transparent Bridge (PPPoE)	Toggles the transparent bridge function on and off.
Profile name list	
Default	Sets the corresponding profile to be the default gateway for all outbound traffic except traffic for which there are configured static route rules or profile routing settings.
Status	Toggles the corresponding profile on and off. If your carrier supports it, two profiles may be turned on simultaneously.
APN	The APN configured for the corresponding profile.
Username	The username used to log on to the corresponding APN.
Roaming settings	
Allow data roaming	When set to ON , the router will allow local devices to access the Wireless WAN network when the it is roaming onto a foreign network. When set to OFF , the router will deny network access to data services when roaming onto a foreign network. This setting is OFF by default.

Table 14 - Data connection item details

Connecting to the mobile broadband network

The router supports the configuration of up to six APN profiles; these profiles allow you to configure the settings that the router will use to connect to the 2G/3G network and switch easily between different connection settings.

For advanced networking purposes, you may activate a maximum of two profiles simultaneously (dependant on network support). When activating two connection profiles, you should avoid selecting two profiles with the same APN as this can cause only one profile to connect. Similarly, activating two profiles which are both configured to automatically determine an APN can cause a conflict and result in neither profile establishing a connection. We recommend that the two active connection profiles have differing, manually configured APNs to avoid connection issues and ensure smooth operation.

Manually configuring a connection profile

To manually configure a connection profile:

1. Click the **Edit** button corresponding to the Profile that you wish to modify. The data connection profile settings page is displayed.

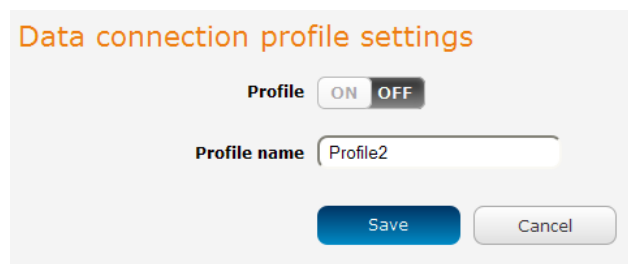
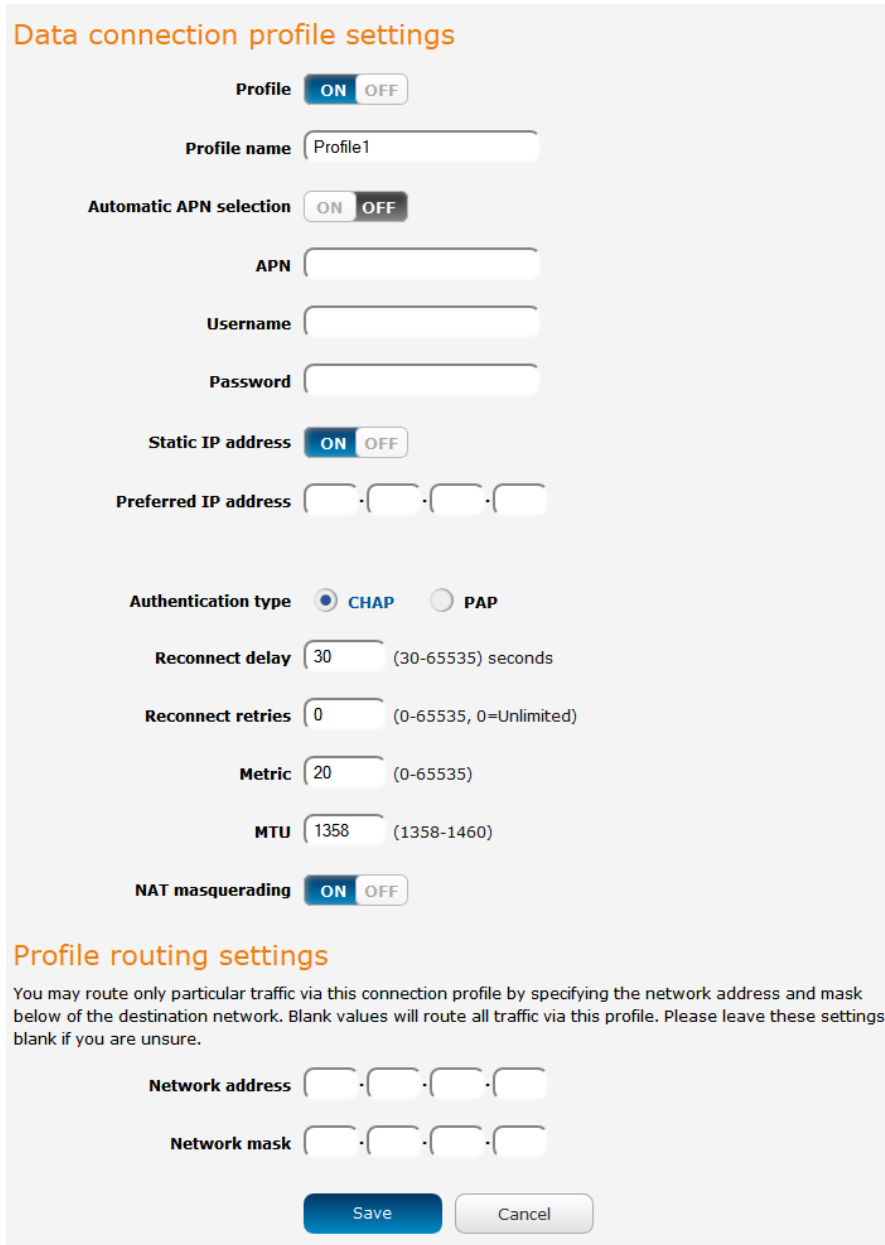

Figure 18 - Data connection profile settings

- Click the **Profile** toggle key to turn the profile on. Additional settings appear.



Data connection profile settings

Profile ON OFF

Profile name

Automatic APN selection ON OFF

APN

Username

Password

Static IP address ON OFF

Preferred IP address . . .

Authentication type CHAP PAP

Reconnect delay (30-65535) seconds

Reconnect retries (0-65535, 0=Unlimited)

Metric (0-65535)

MTU (1358-1460)

NAT masquerading ON OFF

Profile routing settings

You may route only particular traffic via this connection profile by specifying the network address and mask below of the destination network. Blank values will route all traffic via this profile. Please leave these settings blank if you are unsure.

Network address . . .

Network mask . . .

Figure 19 - Data connection settings - Profile turned on

- In the **Profile name** field, enter a name for the profile. This name is only used to identify the profile on the router.
- Ensure that the **Automatic APN selection** toggle key is set to off. If it is not, click it to toggle it to the off position.
- In the **APN** field, enter the APN Name (Access Point Name) and if required, use the **Username** and **Password** fields to enter your login credentials.
- If your mobile broadband carrier allows you to select a preferred IP address, select the **Static IP address** toggle key to turn it to the **ON** position then enter your preferred IP address into the **Preferred IP address** field.
- Next to **Authentication** type, select either CHAP or PAP depending on the type of authentication used by your provider.
- The **Reconnect delay** field specifies the number of seconds to wait between connection attempts. The default setting of 30 seconds is sufficient in most cases but you may modify it to wait up to 65535 seconds if you wish.
- The **Reconnect retries** field specifies the number of times to attempt a network connection if the router fails to establish a connection. It is set to 0 by default which causes the router to attempt to reconnect indefinitely.
- The **Metric** value is used by router to prioritise routes (if multiple are available) and is set to 20 by default. This value is sufficient in most cases but you may modify it if you are aware of the effect your changes will have on the service.

11. The **MTU** field allows you to modify the Maximum Transmission Unit used on the connection. Do not change this unless instructed to by your carrier.
12. Use the **NAT Masquerading** toggle key to turn NAT Masquerading on or off. NAT masquerading, also known simply as NAT is a common routing feature which allows multiple LAN devices to appear as a single WAN IP via network address translation. In this mode, the router modifies network traffic sent and received to inform remote computers on the internet that packets originating from a machine behind the router actually originated from the WAN IP address of the router's internal NAT IP address. This may be disabled if a framed route configuration is required and local devices require WAN IP addresses.
13. For advanced networking such as using dual simultaneous PDP contexts, you may wish to configure a particular profile to route only certain traffic via that profile by configuring a custom address and mask of traffic to send via that profile. To do this, in the Profile routing settings section, enter the **Network address** and **Network mask** of the remote network. If you do not want to use this feature, or are unsure, please leave these fields blank, which will not designate any particular traffic to be routed via this profile. For more information on configuring Profile routing settings, see the [Setting a default gateway with two active connection profiles](#) example.
14. Click the **Save** button when you have finished entering the profile details.

Confirming a successful connection

After configuring the packet data session, and ensuring that it is enabled, click on the Status menu item at the top of the page to return to the Status page. When there is a mobile broadband connection, the **WWAN** section is expanded showing the details of the connection and the Status field displays **Connected**. To see details on the connected session, you can click the **Show data usage** button.

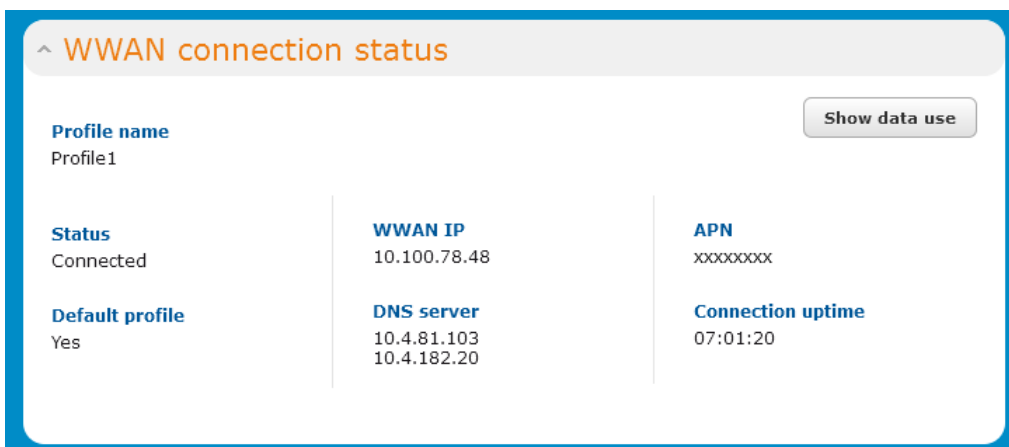

Figure 20 - WWAN connection status section

Transparently bridging the mobile broadband connection via PPPoE

If desired, you can have a client device connected to the Ethernet port initiate the mobile broadband connection using a PPPoE session. This is particularly useful in situations where you wish to provide Wireless WAN data access to an existing router which you want to have full public WAN IP access and have control over routing functionality.

To enable transparent bridging via PPPoE:

1. Click the **Networking** menu item from the top menu bar.
2. On the Data connection page, click the **Transparent bridge (PPPoE)** toggle key so that it is ON.

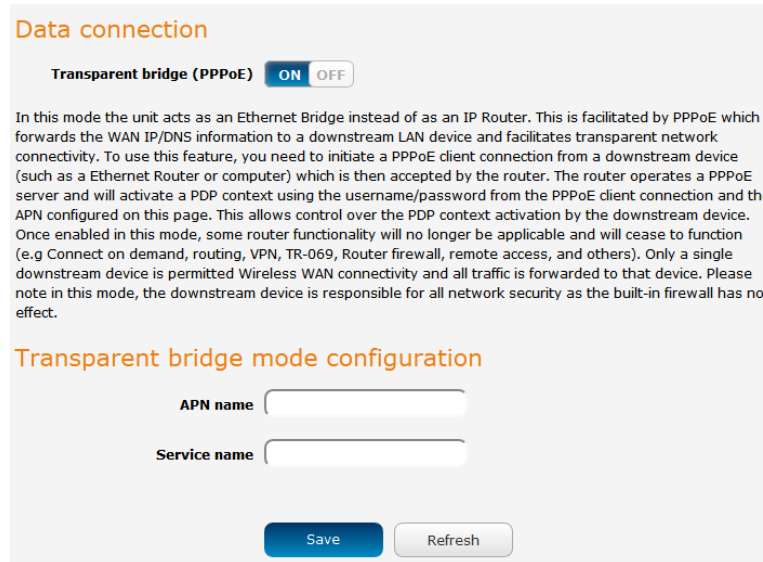

Data connection

Transparent bridge (PPPoE) ON OFF

In this mode the unit acts as an Ethernet Bridge instead of as an IP Router. This is facilitated by PPPoE which forwards the WAN IP/DNS information to a downstream LAN device and facilitates transparent network connectivity. To use this feature, you need to initiate a PPPoE client connection from a downstream device (such as a Ethernet Router or computer) which is then accepted by the router. The router operates a PPPoE server and will activate a PDP context using the username/password from the PPPoE client connection and the APN configured on this page. This allows control over the PDP context activation by the downstream device. Once enabled in this mode, some router functionality will no longer be applicable and will cease to function (e.g Connect on demand, routing, VPN, TR-069, Router firewall, remote access, and others). Only a single downstream device is permitted Wireless WAN connectivity and all traffic is forwarded to that device. Please note in this mode, the downstream device is responsible for all network security as the built-in firewall has no effect.

Transparent bridge mode configuration

APN name

Service name

Figure 21 - Transparent bridge configuration

3. In the APN name field, enter the APN that you wish to use for the mobile broadband connection.
4. (Optional) In the Service name field, enter a name that allows you to easily identify the connection.
5. Click the **Save** button to confirm the settings.
6. Click the Status menu item from the top menu bar to see the transparent bridging status.

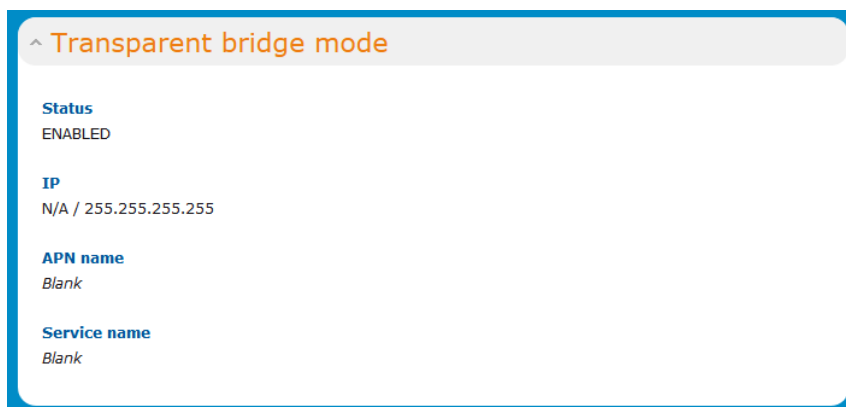

Transparent bridge mode

Status
ENABLED

IP
N/A / 255.255.255.255

APN name
Blank

Service name
Blank

Figure 22 - Transparent bridge mode status

7. Next you must configure your downstream device connected via Ethernet to the NTC-6200 Series router to initiate a network connection through a PPPoE client. The username and password used by the downstream device for the PPPoE session will be passed on and used by the NTC-6200 Series router as the packet data (PDP) context authentication settings.

Connect on demand

The connect on demand feature keeps the Packet Data Protocol (PDP) context deactivated by default while making it appear to locally connected devices that the router has a permanent connection to the mobile broadband network. When a packet of interest arrives or an SMS wake-up command is received, the router attempts to establish a mobile broadband data connection. When the data connection is established, the router monitors traffic and terminates the link when it is idle.



Note: When interesting packets arrive, the recovery time for the wireless WAN connection is approximately 20-30 seconds.

Configuring Connect on demand

To configure Connect on demand:

1. Click the **Networking** menu item from the top menu bar.
2. On the **Connect on demand** page, click the **Connect on demand** toggle key so that it is **ON**. Extra options appear. See the following sub-sections for further instructions.

Connect on demand

The connect on demand feature keeps the PDP context deactivated by default while making it appear that the router has permanent connection to WWAN and locally connected devices. When interesting packets arrive or an SMS wake-up command is received, the router will attempt to establish a WWAN data connection. The router will monitor traffic once the data connection is established and will terminate it when the link is idle.

Connect on demand ON OFF

Data activity triggered connection

Connect only when traffic appears to these UDP/TCP destination ports. You can specify multiple ports by separating them with a comma (eg 21, 23, 53).

Enable dial port filter ON OFF

Connect on data activity except when activity matches these IP protocols

Ignore ICMP ON OFF

Ignore TCP ON OFF

Ignore UDP ON OFF

on data activity except when activity matches these applications

Ignore DNS ON OFF

Ignore NTP ON OFF

Ignore Microsoft network awareness (NCSI) traffic ON OFF

Connect and disconnect timers Periodic connect schedule

On data activity, stay online for at least

After connecting, stay online for at least

After hanging up, don't redial for

Disconnect regardless of traffic after

Connect regularly, every

Randomise connect frequency by up to

Verbose logging configuration

Log all matched activity to the system log ON OFF

Online / Offline control

Online status Disabled

Manual connect
Manual disconnect

Save
Cancel

Figure 23 - Connect on demand configuration options

Setting the router to dial a connection when traffic is detected on specific ports

In some situations, you may wish to have the internet connection disabled except at times when outbound traffic to a particular external host's port or group of ports is sent to the router. To use this feature, click **Enable dial port filter** and enter the port number or list of port numbers separated by commas. When you select this option, all outbound ICMP/TCP/UDP packets to any remote host on the specified port(s) will trigger the connection to dial. Note that when this feature is enabled, the options to ignore specific packet types are not available.

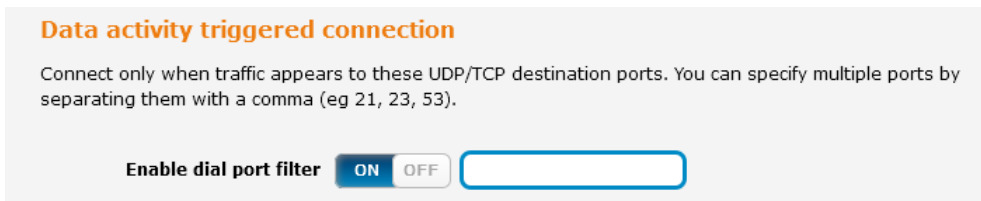

Figure 24 – Connect on demand - Data activity triggered connection

You can allow Microsoft network awareness (NCSI) traffic through but if you prefer that they do not trigger the connection, click the **Ignore Microsoft network awareness (NCSI) traffic** toggle key to set it to **ON**.

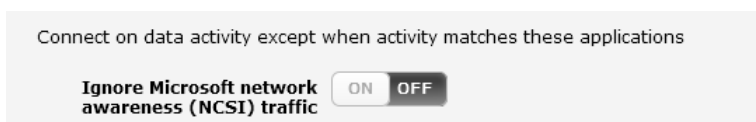

Figure 25 - Connect on demand - Ignore NCSI traffic

Excluding certain packet types from triggering the connection to dial

Depending on your environment, you might prefer to exclude certain types of traffic passing through the router from triggering the data connection. You can tell the router to ignore outbound TCP, UDP or ICMP packets. When any of these options are checked the router will not dial a connection when that type of outbound destined data packet reaches the router from a locally connected device.



Figure 26 – Connect on demand - Excluding IP protocols

Excluding certain application types from triggering the connection to dial

Some devices may generate general traffic as a part of normal operation which you may not want to trigger the data connection. You can set the router to ignore Domain Name System (DNS), Network Time Protocol (NTP) or Microsoft network awareness (NCSI) traffic from devices behind the router. When you check the box for these options, it tells the router to ignore the request from that application type and will not dial a connection when this data type is received.



Figure 27 - Connect on demand - Excluding application types

Setting timers for connection and disconnection

The router has a number of timer settings which let you determine when a connection is dialled and when it is disconnected.

Connect and disconnect timers
Periodic connect schedule

On data activity, stay online for at least

After connecting, stay online for at least

After hanging up, don't redial for

Disconnect regardless of traffic after

Connect regularly, every

Randomise connect frequency by up to

Figure 28 – Connect on demand - Connect and disconnect timers

OPTION	DESCRIPTION
On data activity, stay online for at least	When traffic as per the configured settings above appear, the router will either continue to stay online, or dial a connection and will not disconnect it for the specified time period (min. 1 minute, max. 1 hour). This timer is continuously reset throughout the duration of a dial-up session, whenever data activity is detected matching the rules above.
After connecting, stay online for at least	This timer configures the router to not hang-up the connection for the specified time period after initially dialling the connection. This setting cannot be less than the keep online period above. This timer affects the connection only once per dial up session, at the beginning of the session.
After hanging up, don't redial for	After a connection has been disconnected, you can tell the router to rest for a period of time before re-dialling.
Disconnect regardless of traffic after	Forces the router to disconnect the connection regardless of the traffic passing through it. The default setting is <i>never</i> .
Connect regularly, every / Randomise connect frequency by up to	<p>If you want to have the router dial a connection at regular intervals, use Connect regularly, every to specify the interval between dials. Setting this to <i>never</i> effectively disables this option.</p> <p>The router also features the ability to randomise the time at which the first dial action is performed. This is useful in situations such as where you have numerous routers in an area where a power outage has occurred. Setting a random dial time helps to reduce network congestion when all the routers are powered on so they do not all try to connect simultaneously.</p> <p>When Connect regularly, every is set to at least 2 minutes, you are able to configure the router to randomise the time it begins to dial. The randomised dial timer only affects the initial dial after the unit powers on or after the settings are saved. For example, if you configure the router to dial every 2 minutes with a randomised dial starting time of 1 minute, the router waits for the Connect regularly, every time (2 minutes) and then randomly selects a time less than or equal to the Randomise connect frequency by up to time (1 minute). After the randomly selected time has elapsed, the router dials the connection. After the first dial, the router dials the connection every 2 minutes, ignoring the Randomise connect frequency by up to time.</p>

Table 15 - Connect on demand - Connect and disconnect timers descriptions

Verbose mode

The router provides the option of logging all the data activity which matches the settings for the Connect on demand feature for advanced troubleshooting purposes. To enable the logging of the Connect on demand feature, click the **Enable verbose mode** toggle key to switch it **ON**. See the System log section for more information.

Verbose logging configuration

Log all matched activity to the system log

Figure 29 – Connect on demand - Verbose logging configuration

Manually connecting/disconnecting

There may be times when you need to either force a connection to be made or force a disconnection manually. You can use the **Manual connect** and **Manual disconnect** buttons to do this whenever necessary. The online status of the connection is displayed above the buttons.

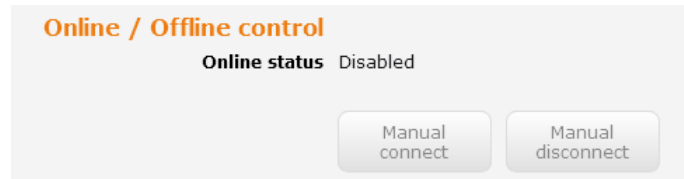

Figure 30 - Connect on demand - Online/Offline control

When you have finished configuring the options for the Connect on demand feature, click the **Save** button at the bottom to save your changes.

SMS Wake up

The router can also be woken up by means of an SMS message using the SMS diagnostics feature by sending an executable wakeup command via SMS. See the [Diagnostics](#) section for details on using the SMS Wake up function.

Operator Settings

The Operator settings page enables you to select which frequency band you will use for your connection and enables you to scan for available network operators in your area.

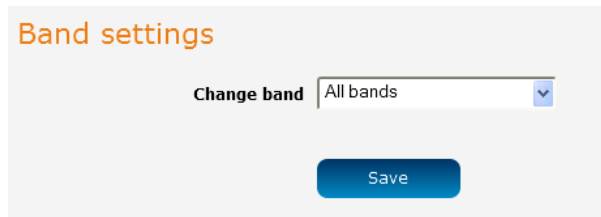

Figure 31 - Band settings



Note: In order to change the operator's band settings, the data connection must be disabled. When you access this page, you are prompted to disable the data connection if it is already active.

You may want to do this if you're using the router in a country with multiple frequency networks that may not all support High Speed Packet Access (HSPA). You can select the router to only connect on the network frequencies that suit your requirements.

Use the **Change band** drop down list to select the band you wish to use.

The following band settings options are available:

-  All Bands
-  GSM All
-  WCDMA All
-  GSM 850
-  GSM 900
-  GSM 1800
-  GSM 1900
-  WCDMA 850
-  WCDMA 900
-  WCDMA 800
-  WCDMA 1900
-  WCDMA 2100

It is not necessary to change the default setting of **All bands** in most cases. In fact, locking to a particular band can cause connection difficulties if the device is moved to a location where the forced band selection is no longer available.

When **All bands** is selected, the router attempts to find the most suitable band based on the available networks for the inserted SIM card.

The GSM All and the WCDMA all options allow you to force the device to lock to either 2G networks only, or 3G networks only.

Click the **Save** button to save and apply your selection.

Operator settings

The operator settings feature allows you perform a scan of available networks, and to optionally lock to a particular network returned by the network scan. To scan for available networks, set the **Select operator mode** from automatic to **Manual** then click the scan button. This operation can take a few minutes and requires that the packet data session be disconnected prior to scanning.

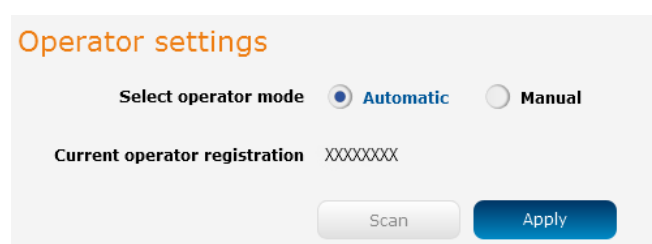

Figure 32 - Operator settings

A list of the detected 3G service carriers in your area is displayed.

Operator name list	MCC	MNC	Operator status	Network type
<input checked="" type="radio"/> Telstra	505	01	Current	UMTS (3G)
<input type="radio"/> Telstra	505	01	Available	GSM (2G)
<input type="radio"/> vodafone AU	505	03	Forbidden	GSM (2G)
<input type="radio"/> YES OPTUS	505	02	Forbidden	GSM (2G)
<input type="radio"/> YES OPTUS	505	02	Forbidden	UMTS (3G)
<input type="radio"/> vodafone AU	505	03	Forbidden	UMTS (3G)

Figure 33 - Detected operator list

Select the most appropriate 3G service from the list shown and click **Apply**.

When **Select operator mode** is set to **Automatic**, the router selects the most appropriate operator based on the inserted SIM card. This is the default option and is sufficient for most users.

SIM security settings

The SIM security settings page can be used for authenticating SIM cards that have been configured with a security PIN.

Unlocking a PIN locked SIM

If the SIM card is locked, you will receive a notice when you access the Status page after which you will be directed to the PIN settings page to enter the PIN. The PIN settings page lists the status of the SIM at the top of the page.

If you are not redirected to the PIN settings page, to unlock the SIM:

- a) Click on the **Networking** menu from the top menu bar, and then click **SIM security settings**.

PIN settings

! SIM is PIN locked - remaining attempt(s) 3

Current PIN

Confirm current PIN

Remember PIN

Figure 34 - SIM security settings - SIM PIN locked

- b) Enter the PIN in the **Current PIN** field and then enter it again in the **Confirm current PIN** field to confirm the PIN.

- c) If you are placing the router in a remote, unattended location, you may wish to check the **Remember PIN** option. This feature allows the router to automatically send the PIN to the SIM each time the SIM asks for it (usually at power up). This enables the SIM to be PIN locked (to prevent unauthorised re-use of the SIM elsewhere), while still allowing the router to connect to the cellular service.

When this feature is enabled, the PIN you enter when setting the **Remember PIN** feature is encrypted and stored locally on the router. The next time the SIM asks the router for the PIN, the router decrypts the PIN and automatically sends it to the SIM without user intervention.

When this feature is disabled and the SIM is PIN locked and the PIN must be manually entered via the router's configuration interface. In situations where the router will be unattended, this is not desirable.



Note: Select **Remember PIN** if you do not want to enter the PIN code each time the SIM is inserted.

- d) Click the **Save** button. If successful, the router displays the following screen:

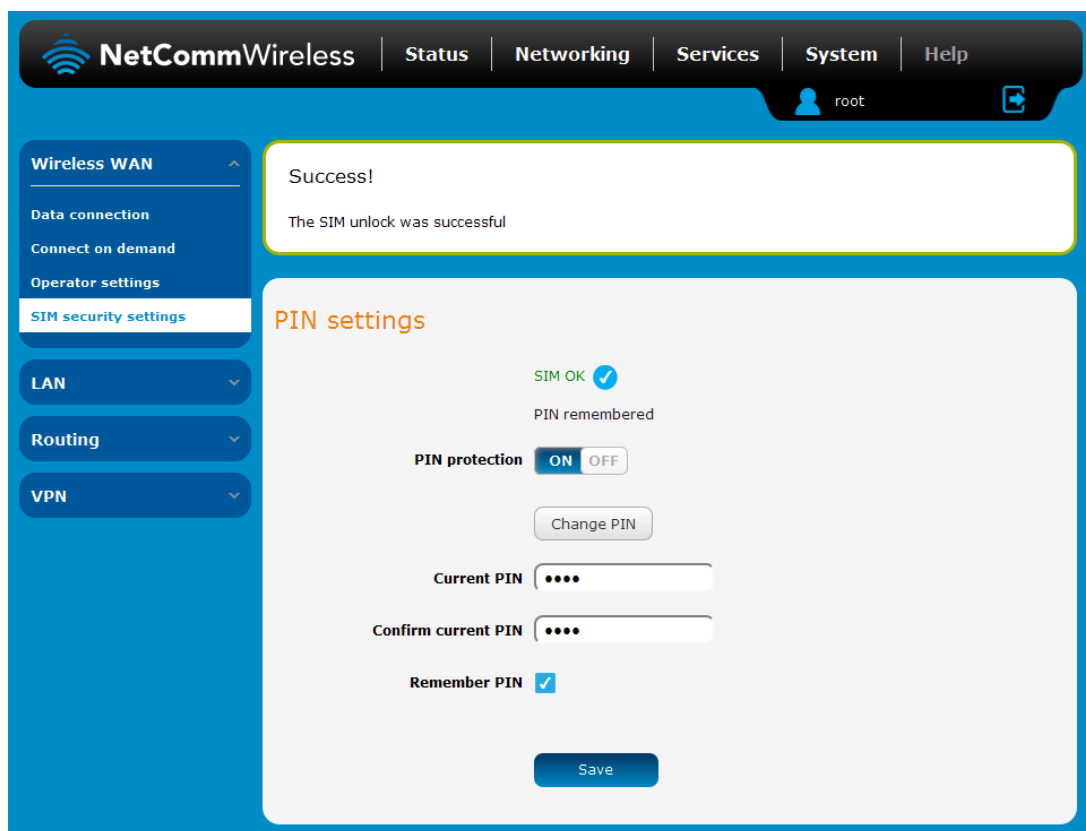
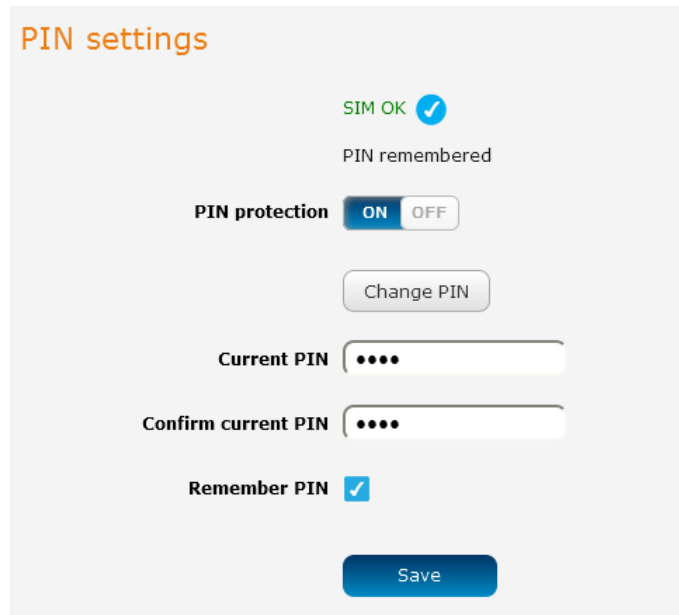

Figure 35 - SIM security settings - SIM unlock successful

Enabling/Disabling SIM PIN protection

The security PIN protection can be turned on or off using the **PIN protection** toggle key.



The screenshot shows the 'PIN settings' page. At the top, it says 'SIM OK' with a green checkmark. Below that, it says 'PIN remembered'. The 'PIN protection' toggle is currently set to 'ON'. There is a 'Change PIN' button. Below that are two input fields for 'Current PIN' and 'Confirm current PIN', both containing four black dots. At the bottom, the 'Remember PIN' toggle is checked, and there is a 'Save' button.

Figure 36 - PIN Settings

Changing the SIM PIN code

If you would like to change the PIN, click the **Change PIN** button and enter the current PIN into the **Current PIN** and **Confirm current PIN** fields, then enter the desired PIN into the **New PIN** and **Confirm new PIN** fields and click the **Save** button.

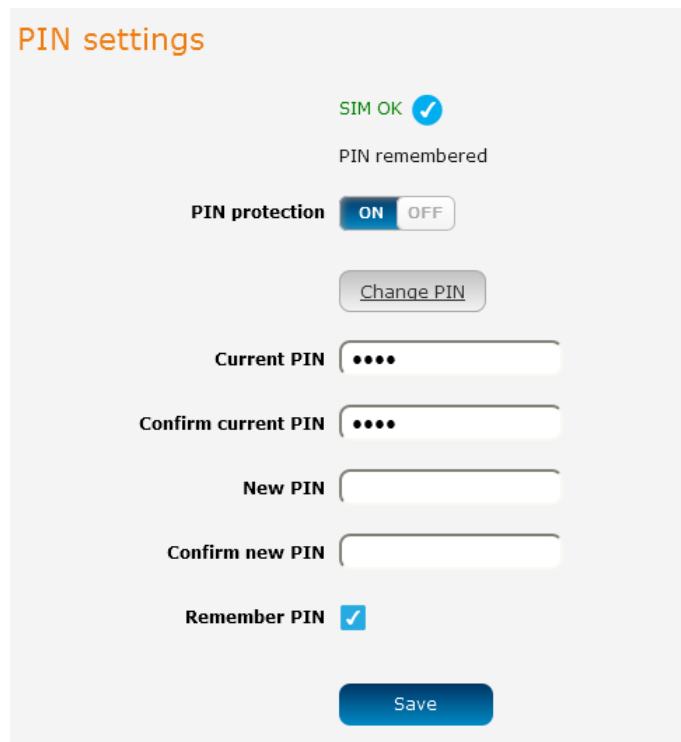

The screenshot shows the 'PIN settings' interface. At the top, it indicates 'SIM OK' with a checkmark and 'PIN remembered'. Below this is a 'PIN protection' toggle switch currently set to 'ON'. A 'Change PIN' button is visible. Underneath are four input fields: 'Current PIN' and 'Confirm current PIN' (both containing four black dots), and 'New PIN' and 'Confirm new PIN' (both empty). At the bottom, there is a 'Remember PIN' checkbox which is checked, and a blue 'Save' button.

Figure 37 - PIN settings - Change PIN

When the PIN has been changed successfully, the following screen is displayed:

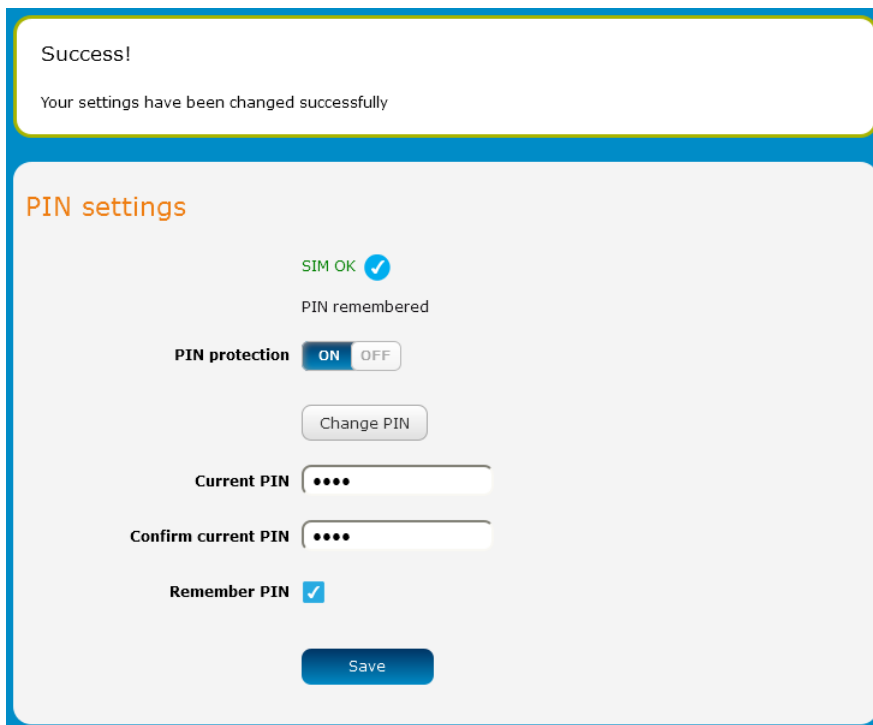

The screenshot shows the 'PIN settings' interface with a success message at the top: 'Success! Your settings have been changed successfully'. The rest of the page is identical to Figure 37, showing the 'PIN settings' form with 'SIM OK', 'PIN remembered', 'PIN protection' (ON), 'Change PIN' button, and the four input fields. The 'Remember PIN' checkbox is checked, and the 'Save' button is present.

Figure 38 - SIM security settings – PIN unlock successful

Unlocking a PUK locked SIM

After three incorrect attempts at entering the PIN, the SIM card becomes PUK (Personal Unblocking Key) locked and you are requested to enter a PUK code to unlock it.



Note: To obtain the PUK unlock code, you must contact your service provider.

You will be issued a PUK to enable you to unlock the SIM and enter a new PIN. Enter the new PIN and PUK codes.

Click the **Save** button when you have finished entering the new PIN and PUK codes.

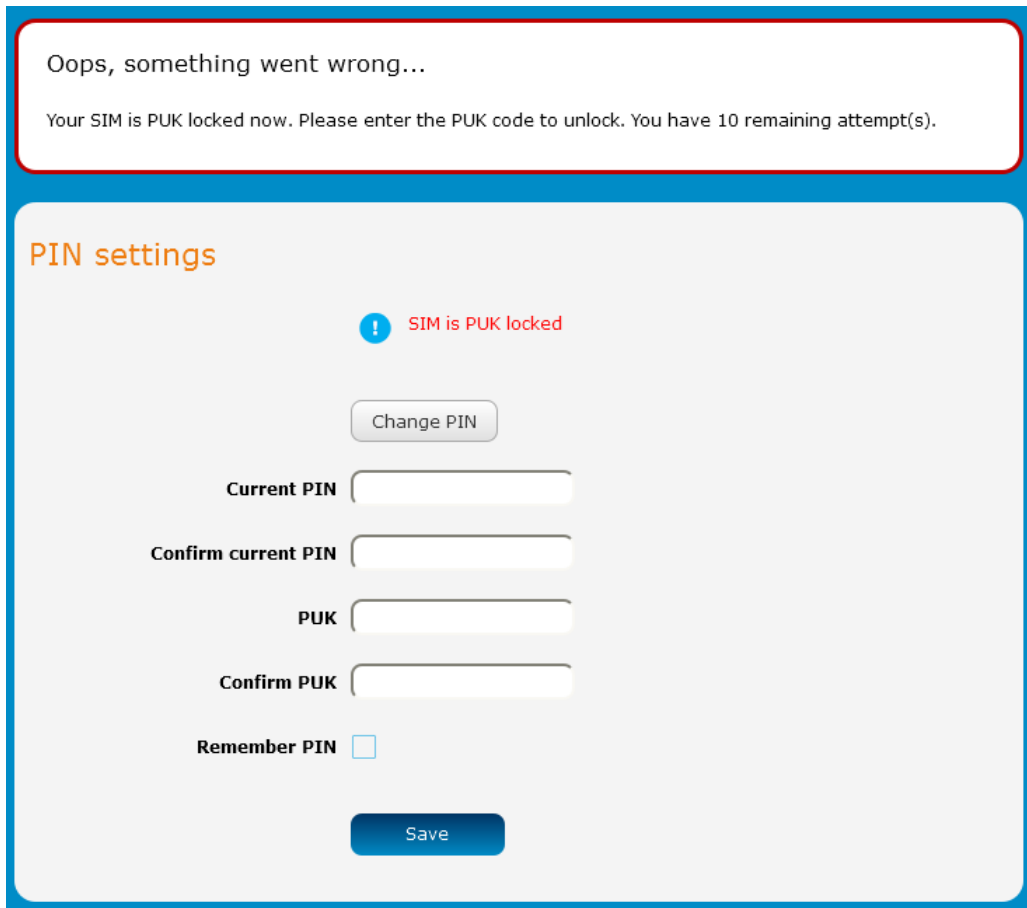

Oops, something went wrong...

Your SIM is PUK locked now. Please enter the PUK code to unlock. You have 10 remaining attempt(s).

PIN settings

 **SIM is PUK locked**

Current PIN

Confirm current PIN

PUK

Confirm PUK

Remember PIN

Figure 39 - SIM security - SIM PUK locked

LAN

LAN configuration

The LAN configuration page is used to configure the LAN settings of the router and to enable or disable DNS Masquerading.

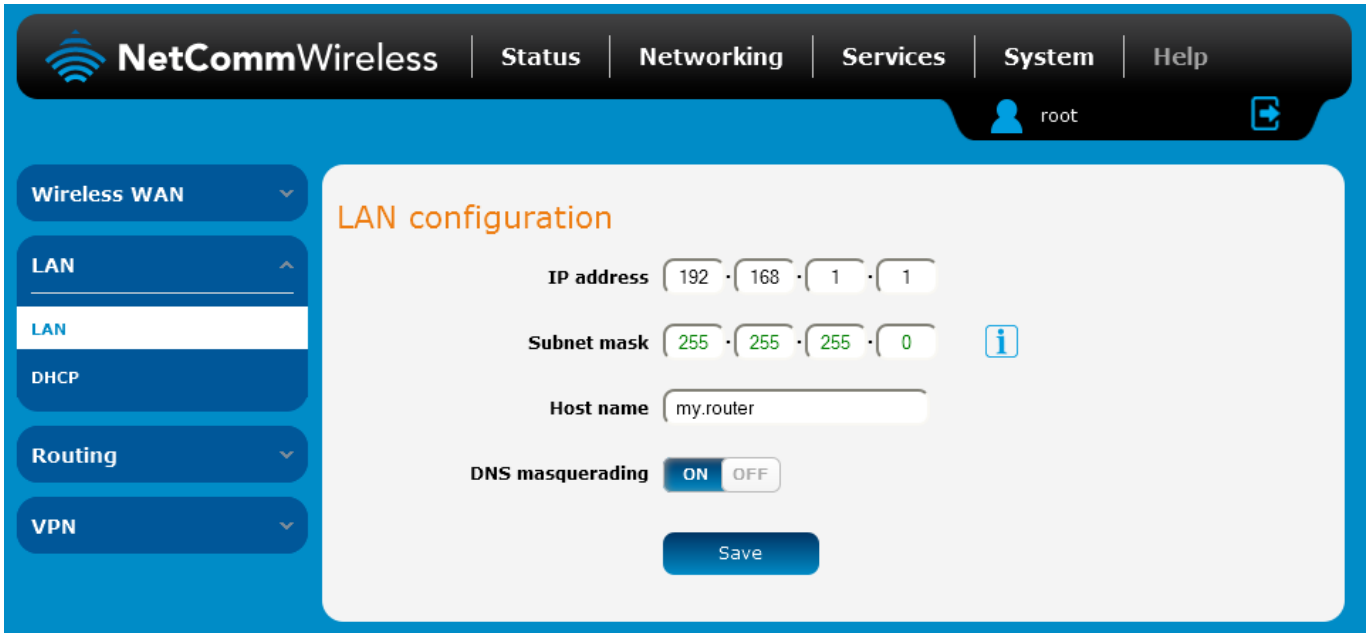

Figure 40 – LAN configuration settings

The default IP of the Ethernet port is 192.168.1.1 with subnet mask 255.255.255.0. To change the IP address or Subnet mask, enter the new IP Address and/or Subnet mask and click the **Save** button.



Note: If you change the IP address, remember to reboot the router and enter the new IP address into your browser address bar.

DNS masquerading

DNS masquerading allows the router to proxy DNS requests from LAN clients to dynamically assigned DNS servers. When enabled, clients on the router's LAN can then use the router as a DNS server without needing to know the dynamically assigned cellular network DNS servers.

With DNS masquerading **ON**, the DHCP server embedded in the NTC-6200 Series router hands out its own IP address (e.g. 192.168.1.1) as the DNS server address to LAN clients. The downstream clients then send DNS requests to the NTC-6200 Series router which proxies them to the upstream DNS servers.

With DNS masquerading **OFF**, the DHCP server hands out the upstream DNS server IP addresses to downstream clients directly, so that downstream clients send DNS requests directly to the upstream DNS servers without being proxied by the NTC-6200 Series router.

You may also override the DNS Masquerading option by specifying custom DNS Server IP addresses in the DHCP Server configuration mentioned in the next section of this guide. In this case the DHCP server assigns downstream devices the manually configured addresses and the DNS Masquerading option is ignored.

In most cases, it is not necessary to disable DNS masquerading but if you need to, click the **DNS masquerading** toggle key to turn it **OFF** and then click the **Save** button.

DHCP

The DHCP page is used to adjust the settings used by the router's built in DHCP Server which assigns IP addresses to locally connected devices.

DHCP relay configuration

In advanced networks configurations where the NTC-6200 Series router should not be responsible for DHCP assignment, but instead an existing DHCP server is located on the Wireless WAN or LAN connections, the clients behind the NTC-6200 Series router are able to communicate with the DHCP server when DHCP relay is enabled. This enables the NTC-6200 Series router to accept client broadcast messages and to forward them onto another subnet.

To configure the router to act as a DHCP relay agent click the **DHCP relay** toggle key to turn it **ON** and enter the DHCP server address into the **DHCP server address** field. DHCP relay is disabled by default.

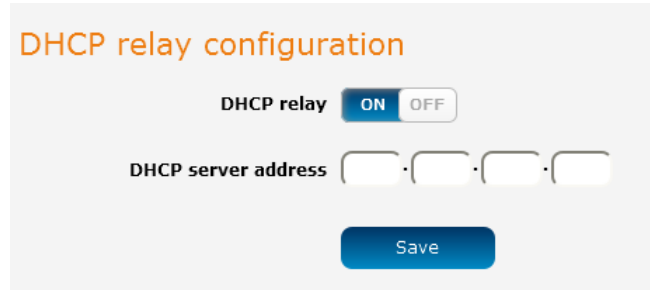

The screenshot shows the 'DHCP relay configuration' interface. At the top, the title 'DHCP relay configuration' is displayed in orange. Below it, there is a 'DHCP relay' toggle switch currently set to 'ON'. Underneath, the 'DHCP server address' field is shown as four empty input boxes separated by dots. At the bottom of the form is a blue 'Save' button.

Figure 41 – DHCP relay configuration

DHCP configuration

You can manually set the start and end address range to be used to automatically assign addresses within, the lease time of the assigned address, the default domain name suffix, primary and secondary DNS server, the primary and secondary WINS server, as well as the advanced DHCP settings such as NTP, TFTP and Option 150/Option 160 (VoIP options).

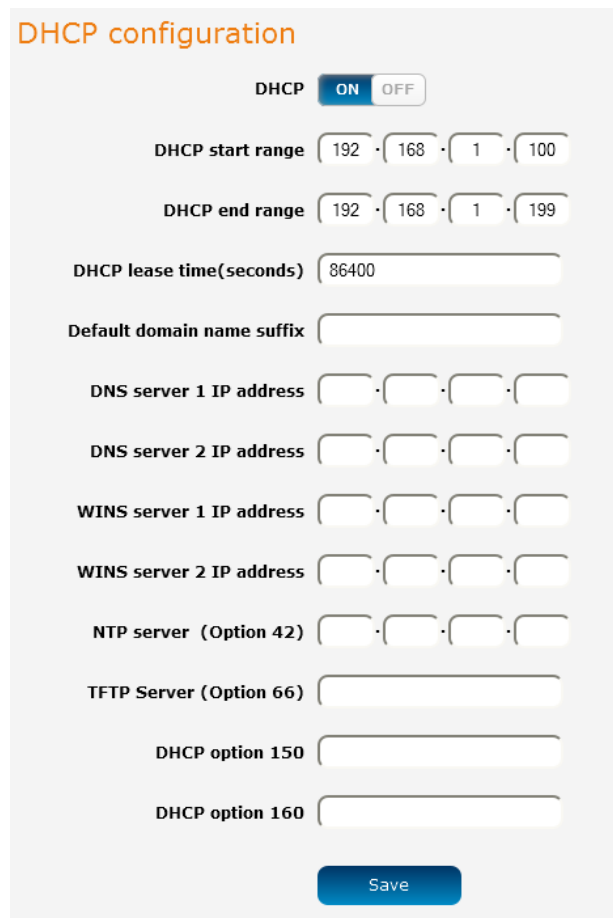

The screenshot shows the 'DHCP configuration' interface. The title 'DHCP configuration' is in orange. A 'DHCP' toggle switch is set to 'ON'. The 'DHCP start range' is set to 192.168.1.100 and the 'DHCP end range' is set to 192.168.1.199. The 'DHCP lease time(seconds)' is set to 86400. Below these are fields for 'Default domain name suffix', 'DNS server 1 IP address', 'DNS server 2 IP address', 'WINS server 1 IP address', 'WINS server 2 IP address', 'NTP server (Option 42)', 'TFTP Server (Option 66)', 'DHCP option 150', and 'DHCP option 160'. A blue 'Save' button is at the bottom.

Figure 42 - DHCP configuration

OPTION	DESCRIPTION
DHCP start range	Sets the first IP address of the DHCP range
DHCP end range	Sets the last IP address of the DHCP range
DHCP lease time (seconds)	The length of time in seconds that DHCP allocated IP addresses are valid
Default domain name suffix	Specifies the default domain name suffix for the DHCP clients. A domain name suffix enables users to access a local server, for example, server1, without typing the full domain name server1.domain.com
DNS server 1 IP address	Specifies the primary DNS (Domain Name System) server's IP address.
DNS server 2 IP address	Specifies the secondary DNS (Domain Name System) server's IP address.
WINS server 1 IP address	Specifies the primary WINS (Windows Internet Name Service) server IP address
WINS server 2 IP address	Specifies the secondary WINS (Windows Internet Name Service) server IP address
NTP server (Option 42)	Specifies the IP address of the NTP (Network Time Protocol) server
TFTP Server (Option 66)	Specifies the TFTP (Trivial File Transfer Protocol) server
DHCP option 150	This is used to configure Cisco IP phones. When a Cisco IP phone starts, if it is not pre-configured with the IP address and TFTP address, it sends a request to the DHCP server to obtain this information. Specify the string which will be sent as a reply to the option 150 request.
DHCP option 160	This is used to configure Polycom IP phones. When a Polycom IP phone starts, if it is not pre-configured with the IP address and TFTP address, it sends a request to the DHCP server to obtain this information. Specify the string which will be sent as a reply to the option 160 request.

Enter the desired DHCP options and click the **Save** button.

Address reservation list

DHCP clients are dynamically assigned an IP address as they connect, but you can reserve an address for a particular device using the address reservation list.

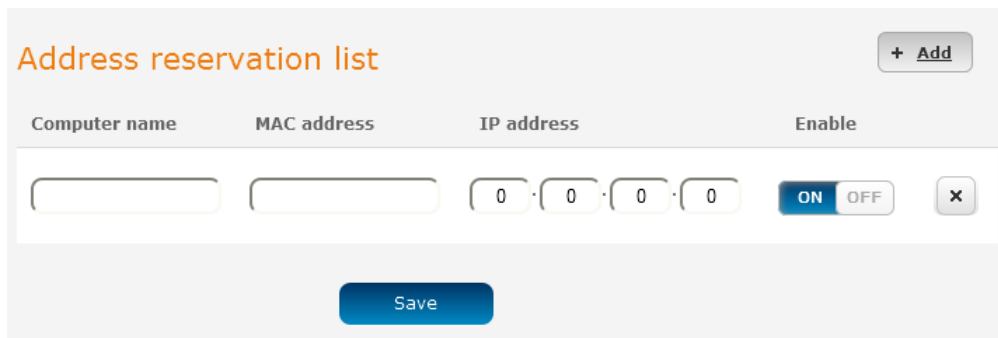

The screenshot shows a web interface for configuring an address reservation list. At the top right is a '+ Add' button. Below it is a table with four columns: 'Computer name', 'MAC address', 'IP address', and 'Enable'. The 'IP address' column contains four input boxes, each with the number '0'. To the right of the IP address boxes is a toggle switch currently set to 'ON', and a close button 'X'. At the bottom center is a blue 'Save' button.

Figure 43 – DHCP – Address reservation list

To add a device to the address reservation list:

1. Click the **+Add** button.
2. In the **Computer Name** field enter a name for the device.
3. In the **MAC Address** field, enter the device's MAC address.
4. In the **IP Address** fields, enter the IP address that you wish to reserve for the device.
5. If the **Enable** toggle key is not set to **ON**, click it to switch it to the **ON** position.
6. Click the **Save** button to save the settings.

Dynamic DHCP client list

The Dynamic DHCP client list displays a list of the DHCP clients. If you want to reserve the current IP address for future use, click the **Clone** button and the details will be copied to the address reservation list fields. Remember to click the **Save** button under the **Address reservation list** section to confirm the configuration.

Computer name	MAC address	IP address	Expiry time	
xxxxxx	00:21:9b:1a:89:ee	192.168.1.146	Thursday, 5 September 2013 12:02:59 PM	

Figure 44 - Dynamic DHCP client list

Ethernet LAN/WAN

The Ethernet LAN/WAN pages provide configuration options for the two built-in Ethernet ports and any USB-to-Ethernet ports you may connect.

Interface assignment

The Interface assignment page displays the Ethernet interfaces and allows you to configure whether they operate in LAN or WAN mode.

To access the Ethernet group page, click on the **Networking** menu at the top of the screen, click on the **Ethernet LAN/WAN** menu on the left then select the **Interface assignment** menu item.

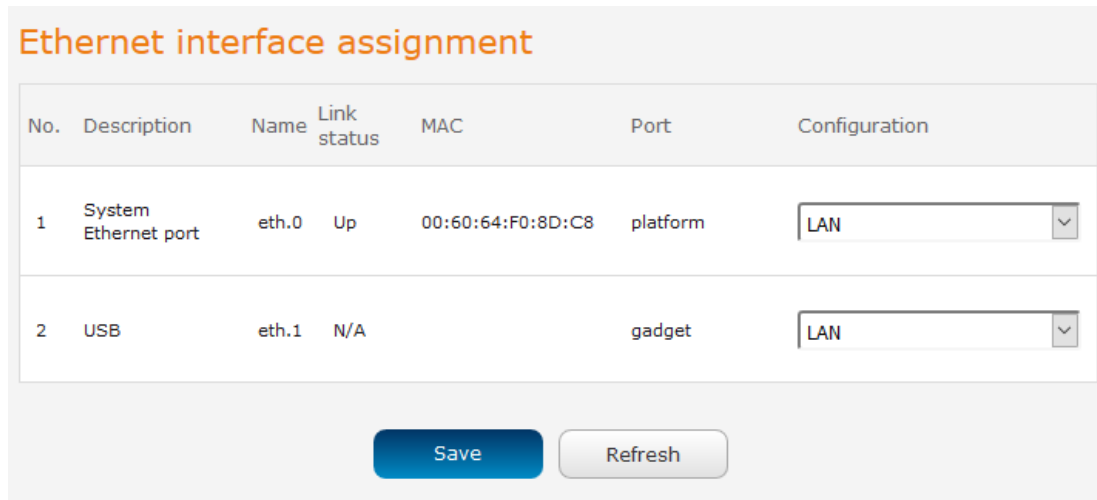

No.	Description	Name	Link status	MAC	Port	Configuration
1	System Ethernet port	eth.0	Up	00:60:64:F0:8D:C8	platform	LAN
2	USB	eth.1	N/A		gadget	LAN

Figure 45 - Ethernet group configuration

OPTION	DEFINITION
#	A number identifying the interface on the router.
Description	A description of the type of interface.
Name	The name used to identify the interface on the router.
Link status	Displays whether the interface is inserted
MAC	The MAC address of the interface.
Port	The type of port.
Configuration	Select whether the port operates as a LAN or WAN port.

Table 16 - Ethernet group configuration items

WAN configuration

The Ethernet WAN configuration page allows you to configure the connection type and metric of the available WAN connections. To access the Ethernet WAN page, click on the **Networking** menu at the top of the screen, click on the **Ethernet LAN/WAN** menu on the left then select the **WAN configuration** menu item.

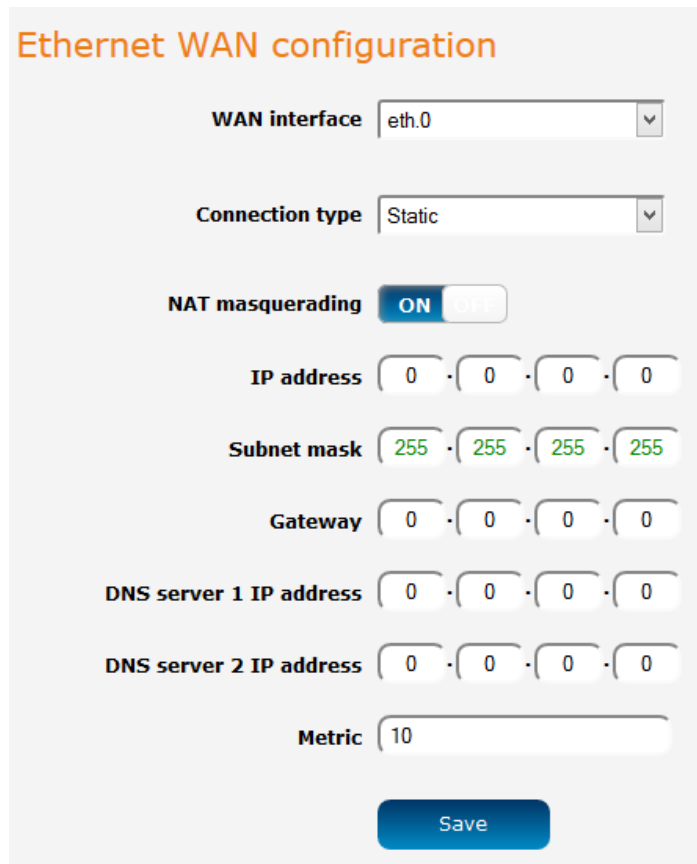

Figure 46 - Ethernet WAN configuration

OPTION	DEFINITION
WAN Ethernet	Use this field to select the WAN interface to configure.
Connection Type	Selects whether the WAN interface has static IP settings or DHCP.
NAT masquerading	NAT masquerading allows the router to modify the packets sent and received to inform remote computers on the internet that packets originating from a machine behind the router actually originated from the WAN IP address of the router's internal NAT IP address.
IP address	The IP address to assign to the selected WAN interface.
Subnet mask	The Subnet mask of the IP address above.
Gateway	The gateway to assign this WAN interface.
DNS server 1 IP address	The first DNS server for the WAN interface.
DNS server 2 IP address	The second DNS server for the WAN interface.
Metric	The metric value is used to define the priority of the interface. Lower metric values indicate higher priority.

Table 17 - Ethernet WAN configuration options

WAN failover

The WAN failover page displays a summary of the configured WAN interfaces and their priorities (Metric). Lower metric values determine higher priority. The priority of the interfaces can be adjusted using the up and down arrows in the Priority column. When the interface with the highest priority goes down, the router fails over to the next highest priority interface. The method used to determine whether an interface is “up” or “down” is defined by the Monitor setting.

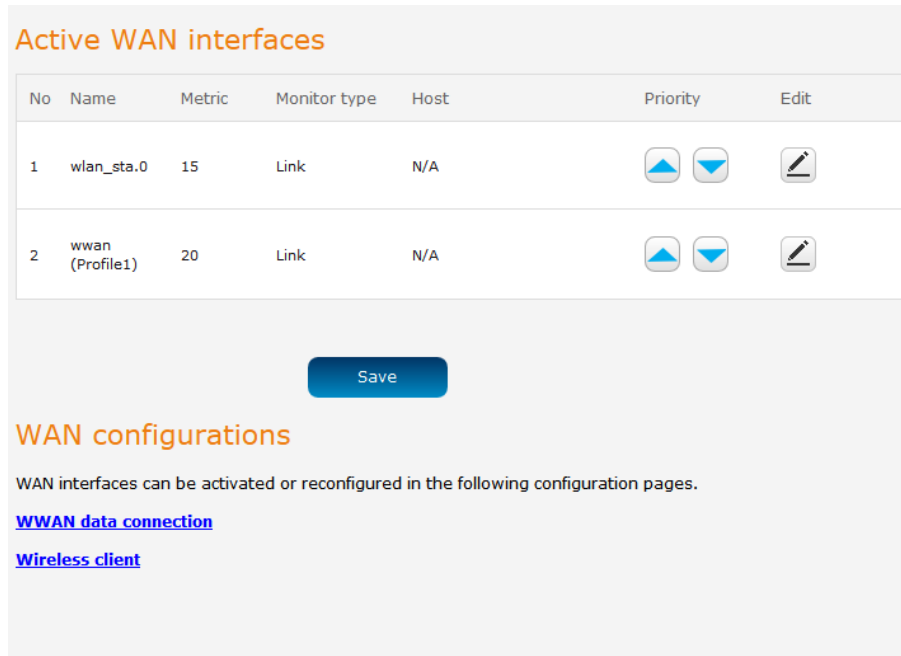

Active WAN interfaces

No	Name	Metric	Monitor type	Host	Priority	Edit
1	wlan_sta.0	15	Link	N/A	▲ ▼	✎
2	wwan (Profile1)	20	Link	N/A	▲ ▼	✎

Save

WAN configurations

WAN interfaces can be activated or reconfigured in the following configuration pages.

[WWAN data connection](#)

[Wireless client](#)

Figure 47 - WAN summary

To edit an interface, select the edit icon for the interface you wish to edit. The Failover configuration page is displayed.



Failover configuration - wlan_sta.0

Priority

Monitoring method

Verbose logging ON OFF

back

Figure 48 – Failover configuration – hardware link

OPTION	DESCRIPTION
Priority	The priority (metric) is a numeric value which determines which interface has priority. Lower priority values mean higher priority.
Monitoring method	Specifies the means used to determine whether the link is up or down.
Verbose logging	When enabled, this logs verbose comments in the system log related to the failover monitoring.

Table 18 - Failover configuration - Hardware link monitoring

Link monitor

By default, an interface is monitored by its link status. This means that the router switches to the WWAN (Profile1) interface when the physical link to eth.0 is broken (i.e. the cable is disconnected or some other hardware fault causes the physical connection to fail). If this is your preferred method of monitoring, select the **Hardware link** option and click the **Save** button to complete the configuration.

Ping monitor

Alternatively, controlled ping packets can be used to determine the status of the link. These are small packets of data that the router sends to a remote address and if the connection is healthy, a reply is received. They are sent indefinitely at regular intervals that you specify. For each WAN interface that is ping monitored, you may specify two separate internet addresses and interval timers for the tests.

Each WAN interface is independently monitored according to its own distinct settings, following the process outlined below.

- At a regular interval stipulated by the **Periodic ping timer** setting, the router sends 3 ping requests via the interface to both the first and second destination addresses simultaneously. If it receives a reply to any of those pings, it deems the connection to be healthy and continues pinging them at the **Periodic ping timer** interval.
- If the router does not receive a response to all six pings by the start of the next **Periodic ping timer** interval, it registers this failure as a **Fail count** and continues to send pings to both destination addresses at the **Retry timer** interval (typically set at a shorter interval than the Periodic ping timer since there may be a problem). If a response is received to any of those pings, the router returns to sending pings according to the **Periodic ping timer** setting.
- However, if after another period defined by the **Retry timer** setting the router again does not receive a response to any of the pings, it registers another **Fail count**.
- The router repeats the retry process until it either receives a ping response (and returns to testing the interface according to the **Periodic ping timer**) or the number configured in the **Fail count** field is reached. In the latter case, that ping monitored interface is marked as unavailable, at which point the router automatically reroutes packets according to the configured priorities of the remaining WAN interfaces.

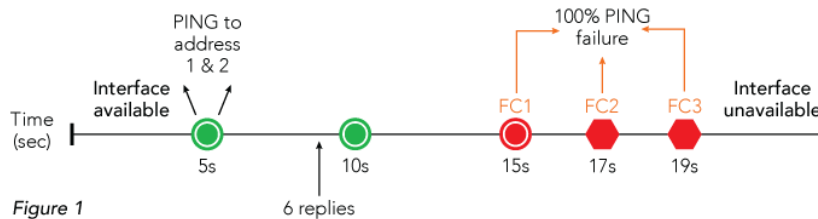

Figure 1

- The process for returning an unavailable interface to an available state is similar to the above process. When an interface is marked unavailable by the ping monitor, the router continues to retry pings to the two destination addresses via that interface according to the **Retry timer** setting until it receives a 100% successful response to the six pings before the next retry. The router then switches to the **Periodic ping timer** interval, waiting for 100% successful responses for an amount of consecutive periods that equal the configured **Fail count** setting, at which point the WAN interface is marked available.

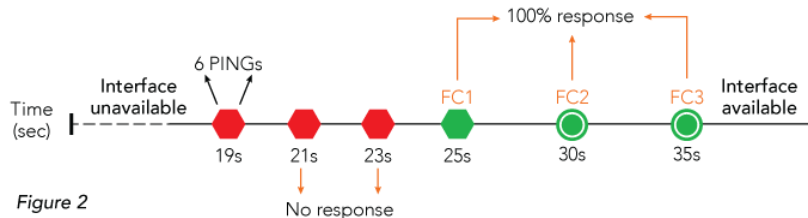
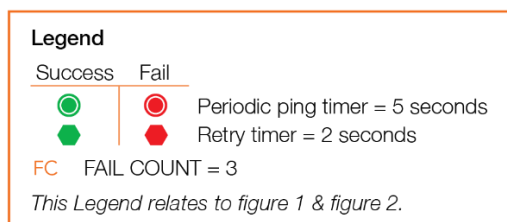

Figure 2



To configure the ping monitor type:

1. Select the Edit  button corresponding to the eth.0 interface.

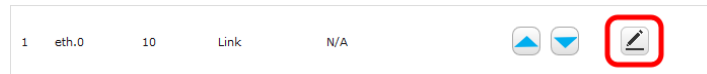

Figure 49 - Ping monitor Edit option

2. Use the **Monitoring method** drop down list to select **Ping**.

Failover configuration - wwan (Profile1)

Metric (0-65535)

Monitoring method ▼

Verbose logging ON OFF

First destination address

Second destination address

Periodic Ping timer (3-65535) secs

Retry timer (2-65535) secs

Consecutive error monitor

Fail/Success count (0=disable, 3-65535) times

Periodic ratio monitor

Monitor total count (0=disable, 3-65535) times

Failover fail count (3-65535) times

Failback success count (3-65535) times

Figure 50 - Ping monitor fail over configuration

3. In the **First destination address** field, enter a website address or IP address to which the router should send the first round of ping requests.
4. In the **Second destination address** field, enter a website address or IP address to which the router should send the second round of ping requests.
5. In the **Periodic Ping timer** field, enter an integer between 3 and 65535 for the number of seconds the router should wait between ping attempts.
6. In the **Retry timer** field, enter an integer between 2 and 65535 for the number of seconds the router should wait between retry ping attempts, i.e. pings to the second destination address.

Using the consecutive error monitor

This is used to watch for consecutive ping events which fail or succeed to determine the reliability of the interface. This method may be used on conjunction with the periodic ratio monitor. When both methods are used, the first method to meet the conditions will cause failover/failback.

7. In the **Fail /success count** field, enter an integer between 3 and 65535 for the number of consecutive times a retry ping should fail before the router fails over to the next WAN interface. Click the **Back** button.

Using the periodic ratio monitor

This is used to watch for a ratio of ping fails and successes over a number of ping events. For example, the default settings stipulate that of the last 10 ping events, if 5 of them should fail, the router fails over to the next highest priority WAN interface. Likewise, if 5 of the last 10 ping events succeed when a lower priority interface is in use, the router will failback to the higher priority one. This method may be used in conjunction with the consecutive error monitor. When both methods are used, the first method to meet the conditions will cause failover/failback.

8. In the **Monitor total count** field, enter the number of historic ping events that should be used when calculating the failover fail count and Failback success count.
9. In the **Failover fail count** field, enter the number of ping events, with respect to the **Monitor total count** figure, that must be reached before the interface is considered as unreliable and failover occurs.
10. In the **Failback success count** field, enter the number of ping events, with respect to the **Monitor total count** figure, that must be reached before the interface is considered as reliable and failback occurs.
11. Click the **Save** button. The Active WAN interfaces are displayed once again, this time showing that the Ping monitor type is in use for eth.0 and the host which will be pinged.

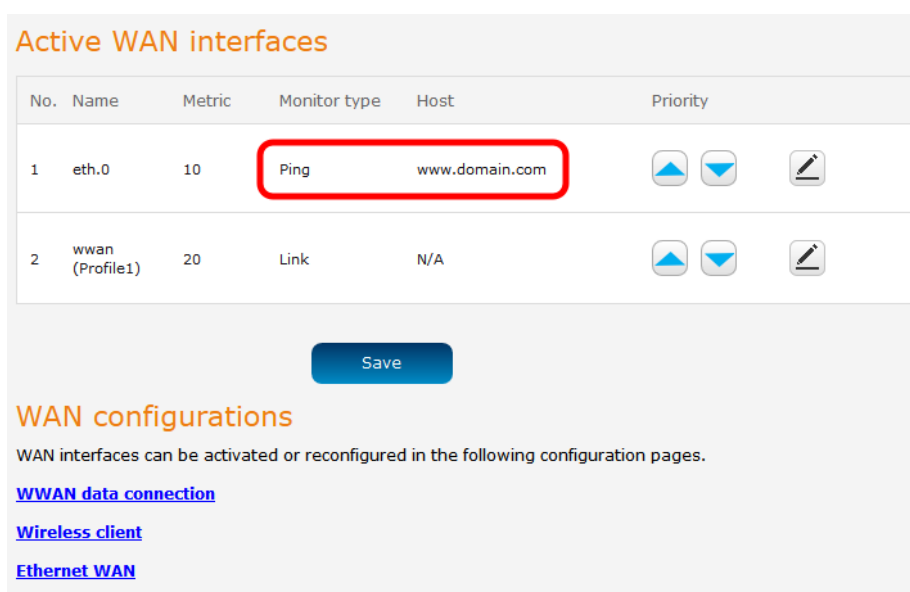

Active WAN interfaces

No.	Name	Metric	Monitor type	Host	Priority
1	eth.0	10	Ping	www.domain.com	▲ ▼ ✎
2	wwan (Profile1)	20	Link	N/A	▲ ▼ ✎

Save

WAN configurations

WAN interfaces can be activated or reconfigured in the following configuration pages.

- [WWAN data connection](#)
- [Wireless client](#)
- [Ethernet WAN](#)

Figure 51 - Active WAN interfaces

12. Click the **Save** button to save the settings. The WAN failover configuration is complete.

Routing

Static

Static routing is the alternative to dynamic routing used in more complex network scenarios and is used to facilitate communication between devices on different networks. Static routing involves configuring the routers in your network with all the information necessary to allow the packets to be forwarded to the correct destination. If you change the IP address of one of the devices in the static route, the route will be broken.

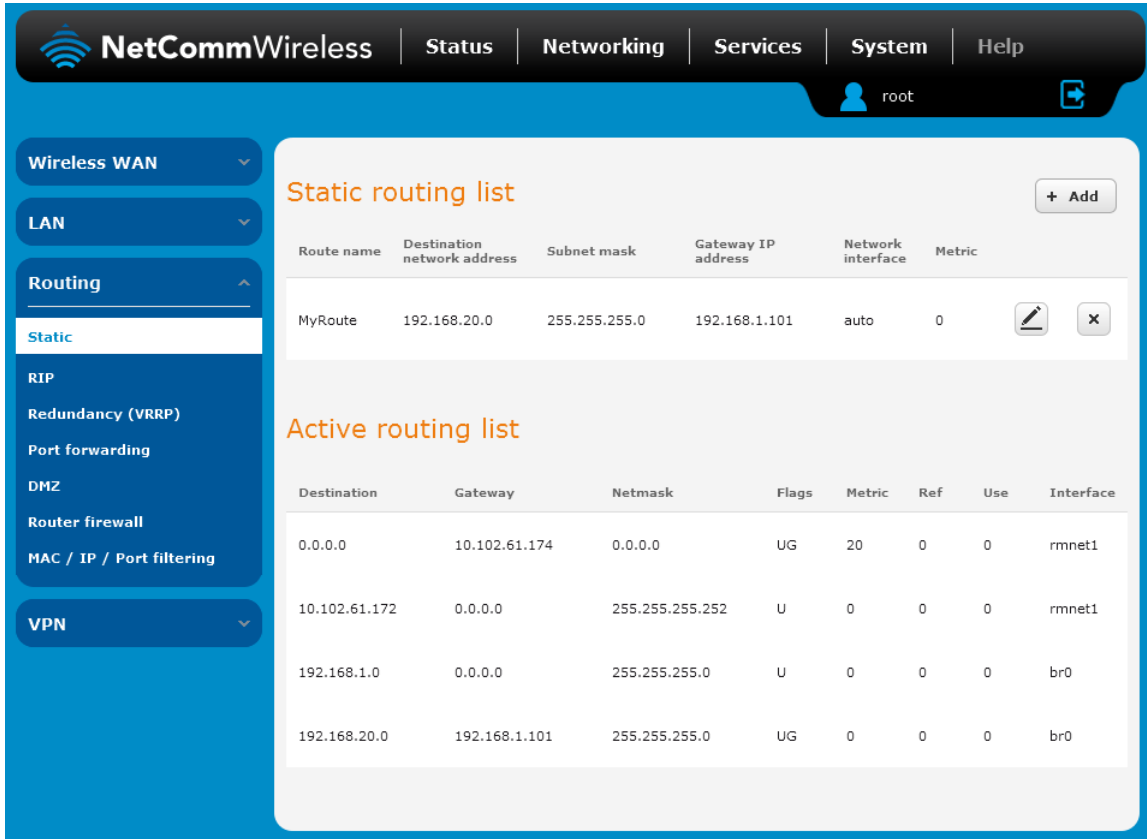

The screenshot shows the NetCommWireless web interface. The top navigation bar includes 'Status', 'Networking', 'Services', 'System', and 'Help'. The user is logged in as 'root'. The left sidebar contains various configuration options, with 'Routing' expanded to show 'Static', 'RIP', 'Redundancy (VRRP)', 'Port forwarding', 'DMZ', 'Router firewall', and 'MAC / IP / Port filtering'. The main content area is titled 'Static routing list' and features a '+ Add' button. Below this is a table with the following data:

Route name	Destination network address	Subnet mask	Gateway IP address	Network interface	Metric
MyRoute	192.168.20.0	255.255.255.0	192.168.1.101	auto	0

Below the static routing list is the 'Active routing list' table:

Destination	Gateway	Netmask	Flags	Metric	Ref	Use	Interface
0.0.0.0	10.102.61.174	0.0.0.0	UG	20	0	0	rmnet1
10.102.61.172	0.0.0.0	255.255.255.252	U	0	0	0	rmnet1
192.168.1.0	0.0.0.0	255.255.255.0	U	0	0	0	br0
192.168.20.0	192.168.1.101	255.255.255.0	UG	0	0	0	br0

Figure 52 - Static routing list

Some routes are added by default by the router on initialization such as the Ethernet subnet route for routing to a device on the Ethernet subnet.

Adding Static Routes

To add a new route to the static routing list, click the **+Add** button. The Static routes page appears.

1. In the **Route name** field, type a name for the route so that it can be identified in the static routing list.
2. From the **Network interface** drop down list, select the interface for which you would like to create a static route.
3. In the **Destination IP address** field, enter the IP address of the destination of the route.
4. In the **IP subnet mask** field, enter the subnet mask of the route.
5. In the **Gateway IP address** field, enter the IP address of the gateway that will facilitate the route.
6. In the **Metric** field enter the metric for the route. The metric value is used by the router to prioritise routes. The lower the value, the higher the priority. To give the route the highest priority, set it to 0.
7. Click the **Save** button to save your settings.

Static routes

Route name

Network interface

Destination network address · · ·

Destination subnet mask · · ·

Gateway IP address · · ·

Metric (0-65535)

Figure 53 - Adding a static route

Active routing list

Static routes are displayed in the Active routing list.

Active routing list

Destination	Gateway	Netmask	Flags	Metric	Ref	Use	Interface
0.0.0.0	10.100.157.33	0.0.0.0	UG	20	0	0	wwan0
10.100.157.32	0.0.0.0	255.255.255.240	U	0	0	0	wwan0
10.100.157.39	0.0.0.0	255.255.255.255	UH	0	0	0	wwan0
192.168.1.0	0.0.0.0	255.255.255.0	U	0	0	0	br0
192.168.20.0	192.168.1.101	255.255.255.0	UG	0	0	0	br0

Figure 54 - Active routing list

Deleting static routes

From the static routing list, click the  icon to the right of the entry you wish to delete.

Static routing list



Route name	Destination network address	Subnet mask	Gateway IP address	Network interface	Metric		
MyRoute	192.168.20.0	255.255.255.0	192.168.1.101	auto	0		

Figure 55 - Deleting a static route

RIP

RIP (Routing Information Protocol) is used for advertising routes to other routers. Thus all the routes in the router's routing table will be advertised to other nearby routers. For example, the route for the router's Ethernet subnet could be advertised to a router on the PPP interface side so that a router on this network will know how to route to a device on the router's Ethernet subnet. Static routes must be added manually according to your requirements. See [Adding Static Routes](#).



Note: Some routers will ignore RIP.

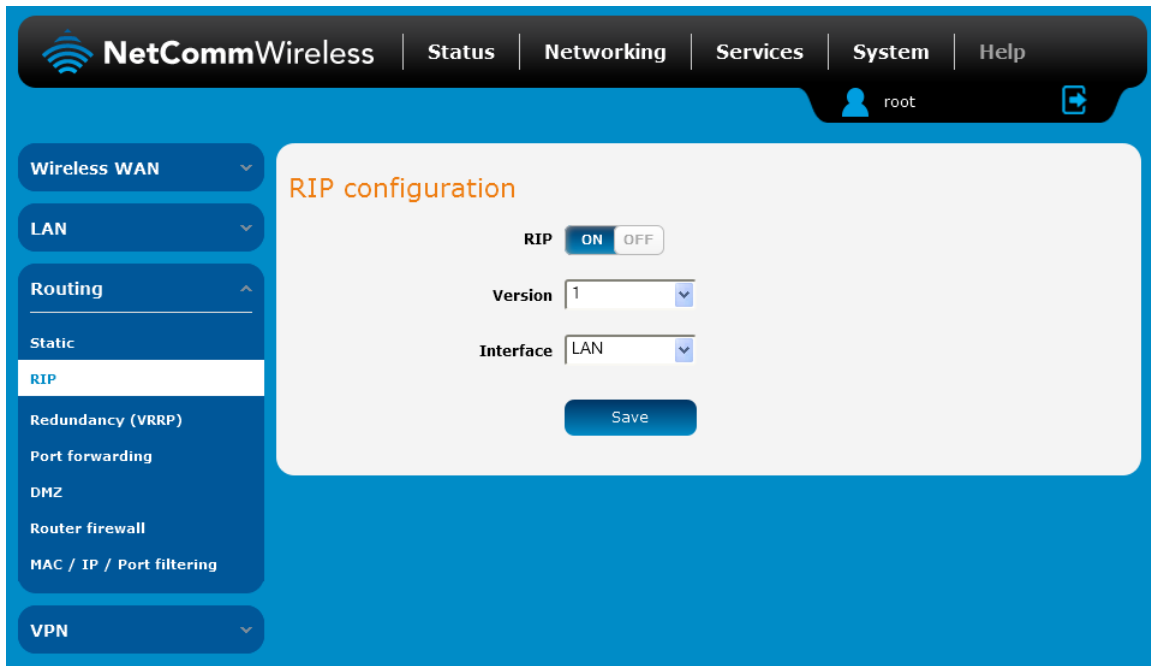

Figure 56 - RIP configuration

To enable Routing Information Protocol (RIP)

1. Click the **RIP** toggle key to switch it to the **ON** position.
2. Using the **Version** drop down list, select the version of RIP that you would like to use.
3. Select the interface for which you want RIP to apply. You can choose the **LAN** interface, the **WWAN** interface or **BOTH**.
4. Click the **Save** button to confirm your settings.

Redundancy (VRRP) configuration

Virtual Router Redundancy Protocol (VRRP) is a non-proprietary redundancy protocol designed to increase the availability of the default gateway servicing hosts on the same subnet. This increased reliability is achieved by advertising a “virtual router” (an abstract representation of master and backup routers acting as a group) as a default gateway to the host(s) instead of one physical router. Two or more physical routers are then configured to stand for the virtual router, with only one doing the actual routing at any given time. If the current physical router that is routing the data on behalf of the virtual router fails, an arrangement is made for another physical router to automatically replace it. The physical router that is currently forwarding data on behalf of the virtual router is called the master router.

Master routers have a priority of 255 and backup router(s) can have a priority between 1 and 254.

A virtual router must use 00-00-5E-00-01-XX as its (MAC) address. The last byte of the address (XX) is the Virtual Router Identifier (VRID), which is different for each virtual router in the network. This address is used by only one physical router at a time, and is the only way that other physical routers can identify the master router within a virtual router.

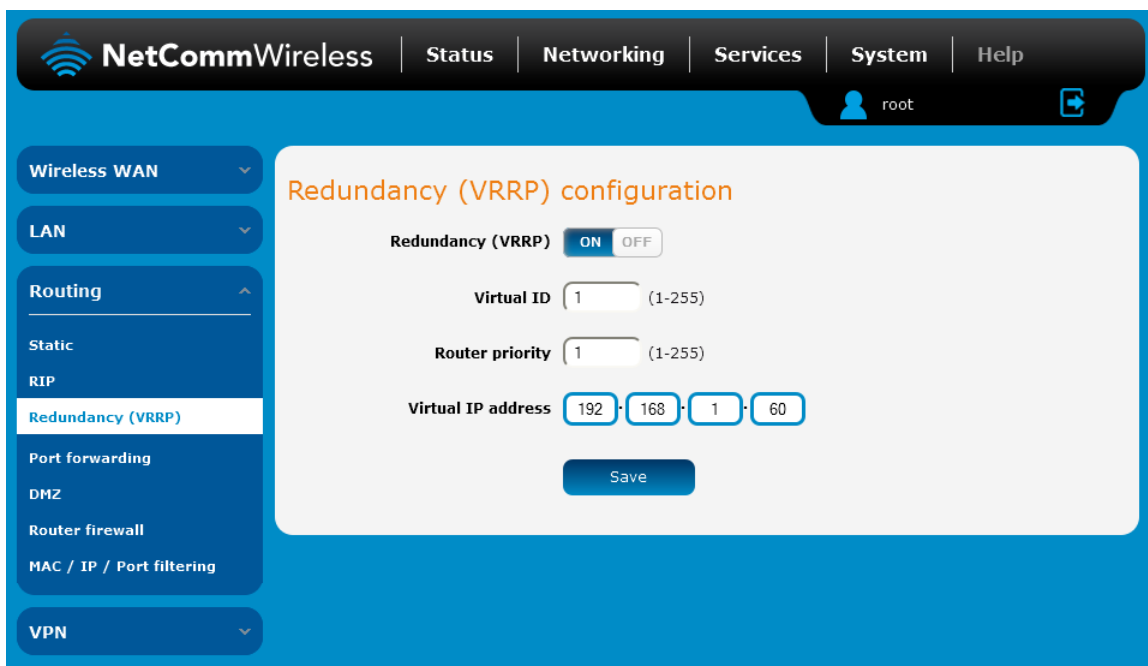

Figure 57 - VRRP configuration

To configure VRRP, configure multiple devices as follows and connect them all via an Ethernet network switch to downstream devices.

1. Click the **Redundancy (VRRP)** toggle key to activate VRRP.
2. In the **Virtual ID** field, enter an ID between 1 and 255. This is the VRRP ID which is different for each virtual router on the network.
3. In the **Router priority** field, enter a value for the priority – a higher value is a higher priority.
4. The **Virtual IP address** field is used to specify the VRRP IP address – this is the virtual IP address that both virtual routers share.
5. Click the **Save** button to save the new settings.



Note: Configuring VRRP changes the MAC address of the Ethernet port and therefore if you want to resume with the web configuration you must use the new IP address (VRRP IP) or on a command prompt type:
`arp -d <ip address>` (i.e. `arp -d 192.168.1.1`) to clear the arp cache.(old MAC address).

Port Forwarding

The Port forwarding list is used to configure the Network Address Translation (NAT) rules currently in effect on the router.

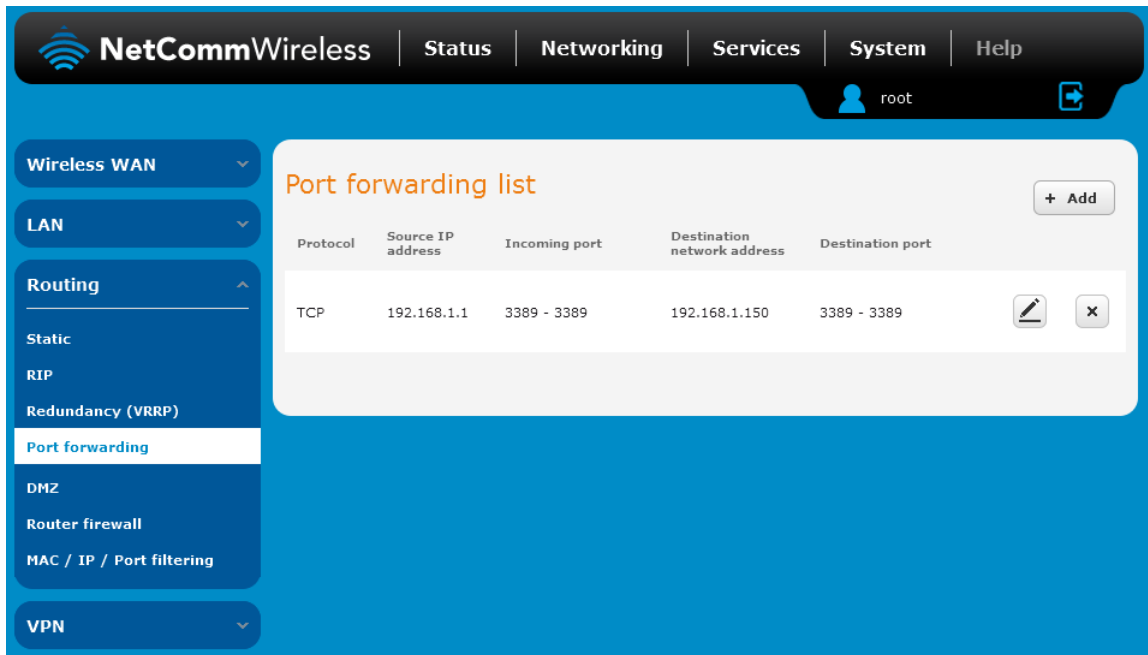

Figure 58 – Port forwarding list

The purpose of the port forwarding feature is to allow mapping of inbound requests to a specific port on the WAN IP address to a device connected on the Ethernet interface.

Adding a port forwarding rule

To create a new port forwarding rule:

6. Click the **+Add** button. The port forwarding settings screen is displayed.
7. Use the **Protocol** drop down list to select the type of protocol you want to use for the rule. The protocols selections available are **TCP**, **UDP** and **All**.
8. In the **Source IP address** field, enter a “friendly” address that is allowed to access the router or a wildcard IP address (0.0.0.0) that allows all IP addresses to access the router.
9. The **Original destination port range (From)** and **(To)** fields are used to specify the port(s) on the source side that are to be forwarded. This allows you to send a range of consecutive port numbers by entering the first in the range in the **(From)** field and the last in the range in the **(To)** field. To forward a single port, enter the port in the **(From)** field and repeat it in the **(To)** field.
10. In the **Destination IP address** field, enter the IP address of the client to which the traffic should be forwarded.
11. The **Destination port range (From)** and **(To)** fields are used to specify the port(s) on the destination side that are to be forwarded. If the Source port range specifies a single port then the destination port may be configured to any port. If the Source port range specifies a range of port numbers then the Destination port range must be the same as the Source port range.
12. Click the **Save** button to confirm your settings.

Port forwarding settings

Protocol

Source IP address · · ·

Original destination port range (From) (1-65535) (To) (1-65535)

Destination IP address · · ·

Destination port range (From) (1-65535) (To) (1-65535)

Figure 59 - Port forwarding settings

To delete a port forwarding rule, click the button on the Port forwarding list for the corresponding rule that you would like to delete.

DMZ

The Demilitarized Zone (DMZ) allows you to configure all incoming traffic on all protocols to be forwarded to a selected device behind the router. This feature can be used to avoid complex port forwarding rules, but it exposes the device to untrusted networks as there is no filtering of what traffic is allowed and what is denied.

The DMZ configuration page is used to specify the IP Address of the device to use as the DMZ host.

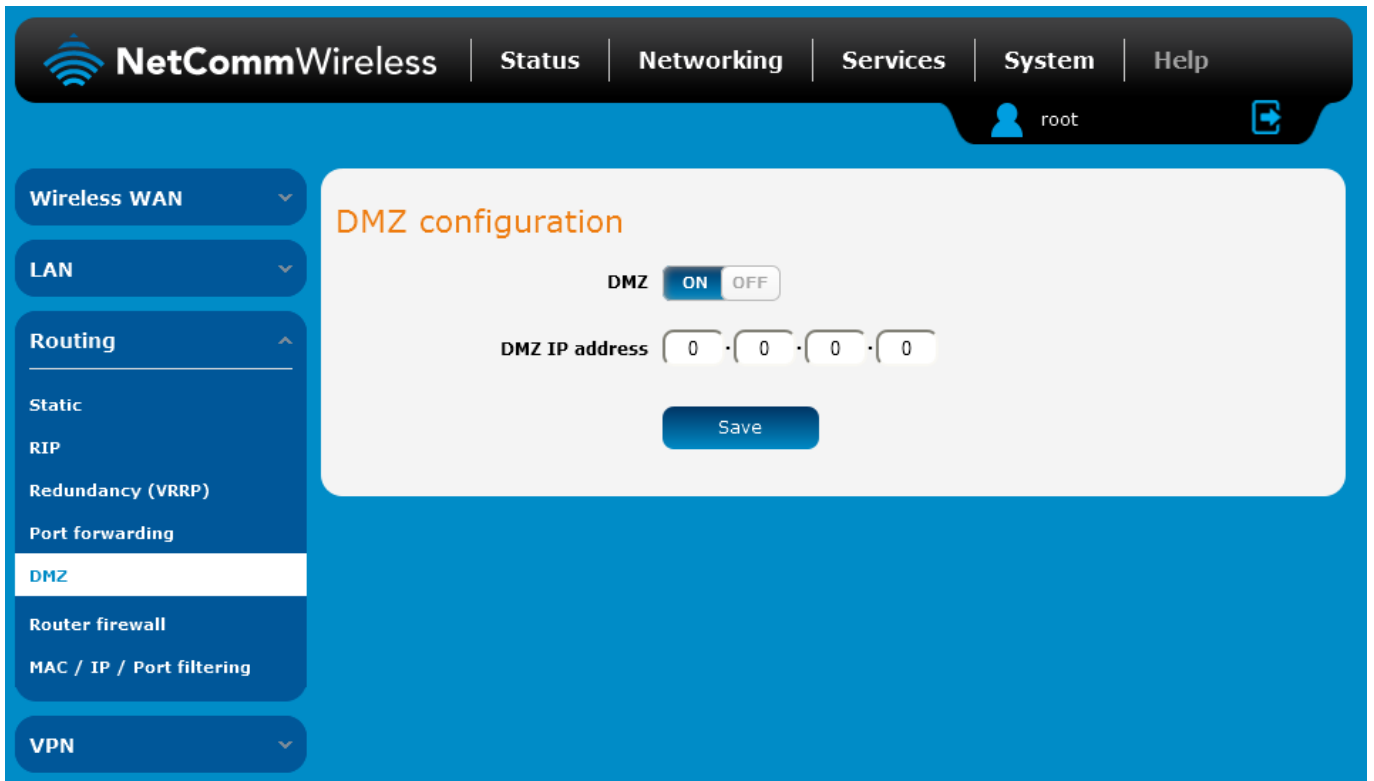

Figure 60 - DMZ configuration

1. Click the DMZ toggle key to turn the DMZ function **ON**.
2. Enter the IP Address of the device to be the DMZ host into the **DMZ IP Address** field.
3. Click the **Save** button to save your settings.

Router firewall

The Router firewall page is used to enable or disable the in-built firewall on the router. When enabled, the firewall performs stateful packet inspection on inbound traffic from the wireless WAN and blocks all unknown services, that is, all services not listed on the Services configuration page of the router.

With respect to the other Routing options on the Networking page, the firewall takes a low priority. The priority of the firewall can be described as:

DMZ > MAC/IP/Port filtering rules > MAC/IP/Port filtering default rule > Router firewall rules

In other words, the firewall is of the lowest priority when compared to other manual routing configurations. Therefore, a MAC/IP/Port filtering rule takes priority in the event that there is a conflict of rules. When DMZ is enabled, MAC/IP/Port filtering rules and the router firewall are ignored but the router will still honour the configuration of the Remote router access control settings listed under Administration Settings.

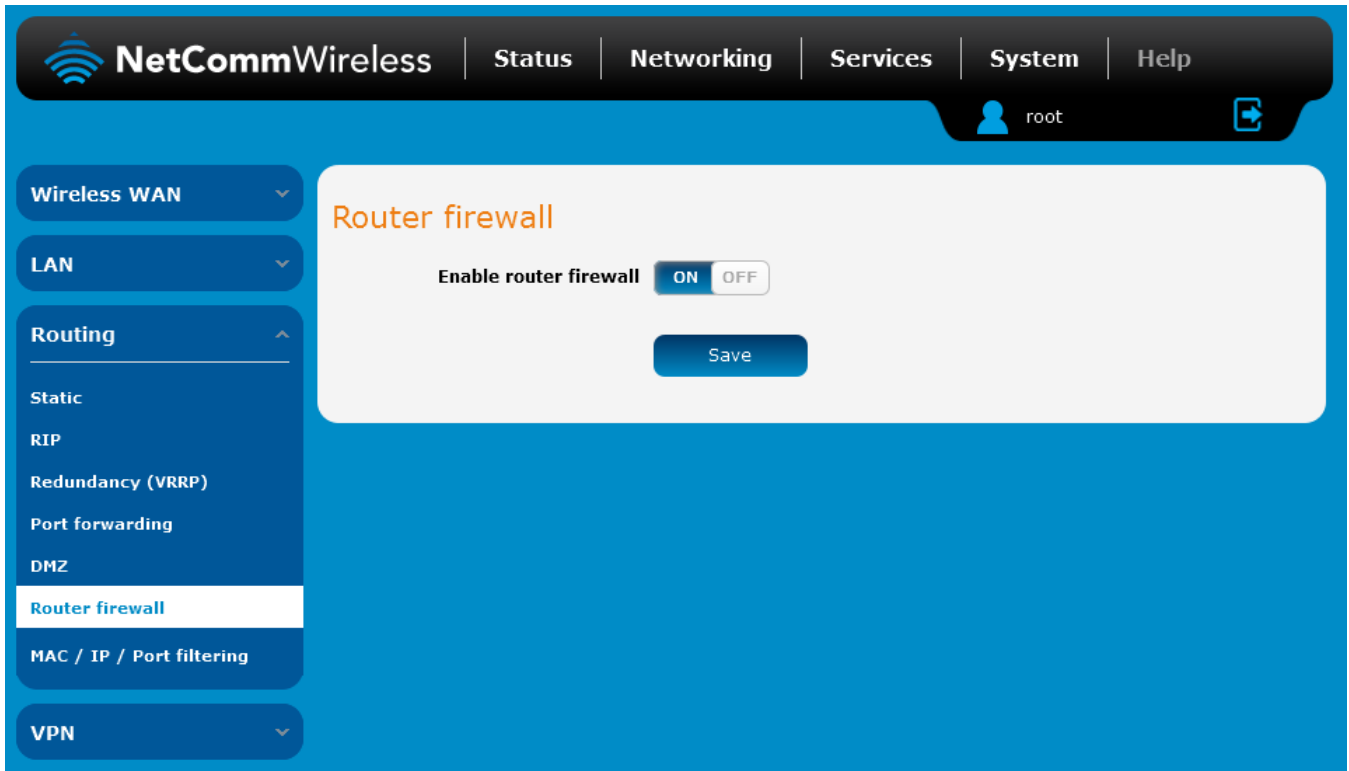

Figure 61 - Router firewall toggle key

MAC / IP / Port filtering

The MAC/IP/Port filter feature allows you apply a policy to the traffic that passes through the router, both inbound and outbound, so that network access can be controlled. When the filter is enabled with a default rule of “Accepted”, all connections will be allowed except those listed in the “Current MAC / IP / Port filtering rules in effect” list. Conversely, when the default rule is set to “Dropped”, all connections are denied except for those listed in the filtering rules list.

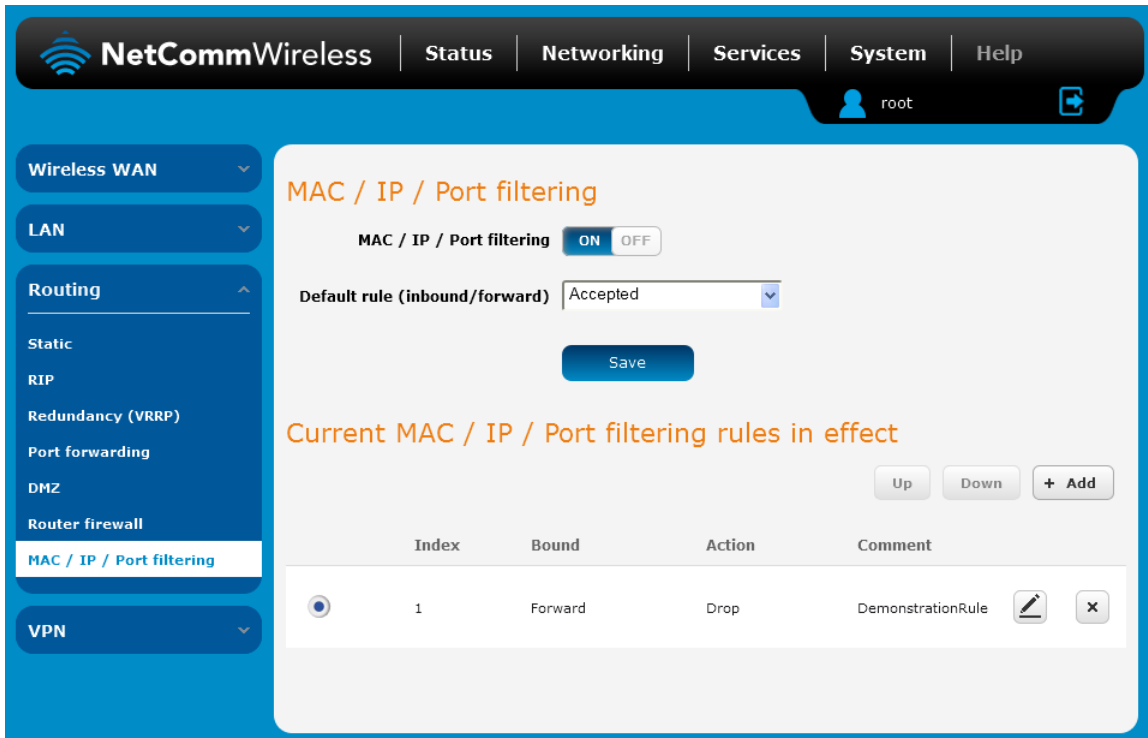

Figure 62 - MAC / IP / Port filtering



Note: When enabling MAC / IP / Port filtering and setting the default rule to “Dropped”, you should ensure that you have first added a filtering rule which allows at least one known MAC/IP to access the router, otherwise you will not be able to access the user interface of the router without resetting the router to factory default settings.

Creating a MAC / IP / Port filtering rule

To create a filtering rule:

1. Click the **MAC / IP / Port filtering** toggle key to switch it to the **ON** position.
2. Using the **Default rule (inbound/forward)** drop down list, select the default action for the router to take when traffic reaches it. By default, this is configured to **Accepted**. If you change this to **Dropped**, you should first configure a filter rule that allows at least one device access to the router, otherwise you will effectively be locked out of the router.
3. Click the **Save** button to confirm the default rule.
4. In the Current MAC / IP / Port filtering rules in system section, click the **+Add** button.



Figure 63 - Current MAC / IP / Port filtering rules in effect

5. Enter the details of the rule in the section that is displayed and click the **Save** button.

MAC / IP / Port filter settings

Bound

Protocol

Source MAC address

Source IP address · · · /

Destination IP address · · · /



Action

Comment

Figure 64 - MAC / IP / Port filtering settings

OPTION	DESCRIPTION
Bound	Use the drop down list to select the direction of the traffic for which you want to apply to the rule. Inbound refers to all traffic that is entering the router including data entering from the WAN and the LAN. Outbound refers to all traffic exiting the router including traffic leaving in the direction of the WAN and traffic leaving in the direction of the LAN. Forward specifies traffic that enters on the LAN or WAN side and is forwarded to the opposite end.
Protocol	Use the drop down list to select the protocol for the rule. You can have the rule apply to All protocols, TCP , UDP , UDP/TCP or ICMP .
Source MAC Address	Enter the MAC address in six groups of two hexadecimal digits separated by colons (:). e.g. 00:40:F4:CE:FA:1E
Source IP Address	Enter the IPv4 address that the traffic originates from and the subnet mask using CIDR notation.
Destination IP Address	Enter the IPv4 address that the traffic is destined for and the subnet mask using CIDR notation.
Action	Select the action to take for traffic which meets the above criteria. You can choose to Accept or Drop packets. When the default rule is set to Accept , you cannot create a rule with an Accept action since the rule is redundant. Likewise, if the default rule is set to Dropped you cannot create a rule with a Drop action.
Comment	[Optional] Use this field to enter a comment as a meaningful description of the rule.

Table 19 - Current MAC / IP / Port filtering rules in effect

6. The new rule is displayed in the filtering rules list. You can edit the rule by clicking the  **Edit** button or delete the rule by clicking the  button.

Current MAC/IP/Port filtering rules in system



	Index	Bound	Action	Comment	
<input checked="" type="radio"/>	1	Forward	Drop	Demonstration rule	 

Figure 65 - Completed filtering rule

VPN

A Virtual Private Network (VPN) is a tunnel providing a private link between two networks or devices over a public network. Data to be sent via a VPN needs to be encapsulated and as such is generally not visible to the public network.

The advantages of a VPN connection include:

-  Data Protection
-  Access Control
-  Data Origin Authentication
-  Data Integrity

Each VPN connection has different configuration requirements. The following pages detail the configuration options available for the different VPN connection types.



Note: The following descriptions are an overview of the various VPN options available. More detailed instructions are available in separate whitepapers on the NetComm Wireless website.

IPSec

IPSec operates on Layer 3 of the OSI model and as such can protect higher layered protocols. IPSec is used for both site to site VPN and Remote Access VPN. The NTC-6200 Series router supports IPSec end points and can be configured with Site to Site VPN tunnels with third party VPN routers.

Configuring an IPSec VPN

From the menu at the top of the screen, click **Networking** and under the VPN section, click **IPSec**. A list of configured IPSec VPN connections is displayed.

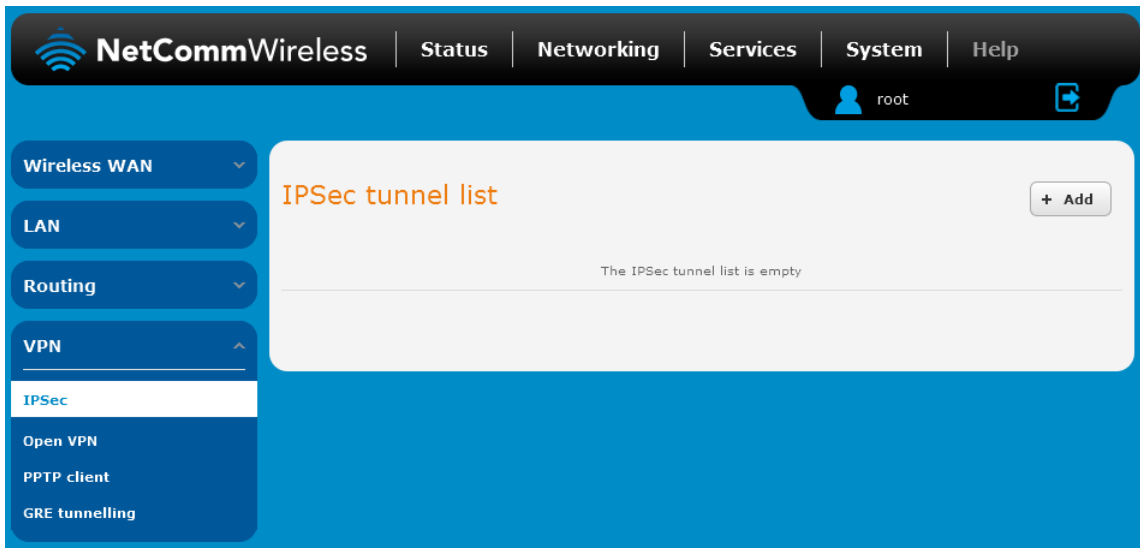

Figure 66 - IPSec VPN List

Click the **+Add** button to begin configuring an IPSec VPN connection.

IPSec profile edit

IPSec profile ON OFF

Profile name

Phase 1 parameters

Remote IPSec address

Key mode

Pre-shared key

Remote ID (xy.sample.com or blank)

Local ID (xy.sample.com or blank)

IKE mode

PFS

IKE encryption

IKE hash

DH group

IKE re-key time (0-78400, 0=Unlimited) secs

DPD action

DPD keep alive time secs

DPD timeout secs

SA life time (0-78400, 0=Unlimited) secs

Phase 2 parameters

Remote LAN address · · ·

Remote LAN subnet mask · · ·

Local LAN address · · ·

Local LAN subnet mask · · ·

Encapsulation type

IPSec encryption

IPSec hash

Figure 67 – IPSec profile edit

The following table describes each of the fields of the IPSec VPN Connection Settings page.

ITEM	DEFINITION
IPSec profile	Enables or disables the VPN profile.
Profile name	A name used to identify the VPN connection profile.
Remote IPSec address	The IP address or domain name of the IPSec server.
Key mode	Select the type of key mode in use for the VPN connection. You can select from: <ul style="list-style-type: none"> • Pre Shared Key • RSA keys • Certificates
Pre-shared key	The pre-shared key is the key that peers used to authenticate each other for Internet Key Exchange.
Update Time	Displays the last time the key was updated.
Local RSA Key Upload	Select the RSA key file for the local router here by clicking the Browse button.
Remote RSA Key Upload	Select the RSA key file for the remote router here by clicking the Browse button.
Private key Passphrase	The Private key passphrase of the router is the passphrase used when generating the router's private key using OpenSSL CA.
Key / Certificate	Select the type of key or certificate to use for authentication. You can select Local private key, Local public certificate, Remote public certificate, CA certificate, CRL certificate.
IPSec Certificate Upload	Select the IPSec certificate to upload by clicking the Browse button.
Remote ID	Specifies the domain name of the remote network.
Local ID	Specifies the domain name of the local network.
IKE mode	Select the IKE mode to use with the VPN connection. You can choose Main, Aggressive or Any .
PFS	Choose whether Perfect Forward Secrecy is ON or OFF for the VPN connection.
IKE encryption	Select the cipher type to use for the Internet Key Exchange.
IKE hash	Select the IKE Hash type to use for the VPN connection. The hash is used for authentication of packets for the key exchange.
DH group	Select the desired Diffie-Hellman group to use. Higher groups are more secure but also require longer to generate a key.
IKE re-key time	Enter the time in seconds between changes of the encryption key. To disable changing the key, set this to 0.
DPD action	Select the desired Dead Peer Detection action. This is the action to take when a dead Internet Key Exchange Peer is detected.
DPD keep alive time	Enter the time in seconds for the interval between Dead Peer Detection keep alive messages.
DPD timeout	Enter the time in seconds of no response from a peer before Dead Peer Detection times out.
SA life time	Enter the time in seconds for the security association lifetime.
Remote LAN address	Enter the IP address of the remote network for use on the VPN connection.
Remote LAN subnet mask	Enter the subnet mask in use on the remote network.
Local LAN address	Enter the IP address of the local network for use on the VPN connection.
Local LAN subnet mask	Enter the subnet mask in use on the local network.
Encapsulation type	Select the encapsulation protocol to use with the VPN connection. You can choose ESP, AH or Any .
IPSec encryption	Select the IPSec encryption type to use with the VPN connection.
IPSec hash	Select the IPSec hash type to use for the VPN connection. The hash is used for authentication of packets for the VPN connection.

Table 20 - IPSec Configuration Items

OpenVPN

OpenVPN is an open source virtual private network (VPN) program for creating point-to-point or server-to-multi-client encrypted tunnels between host computers. It can traverse network address translation (NAT) and firewalls and allows authentication by certificate, pre-shared key or username and password. OpenVPN works well through proxy servers and can run over TCP and UDP transports. Support for OpenVPN is available on several operating systems, including Windows, Linux, Mac OS, Solaris, OpenBSD, FreeBSD, NetBSD and QNX.

Configuring an Open VPN server

From the menu at the top of the screen, click **Networking** and from the VPN section on the left, click **OpenVPN**. A list of configured OpenVPN VPN connections is displayed.

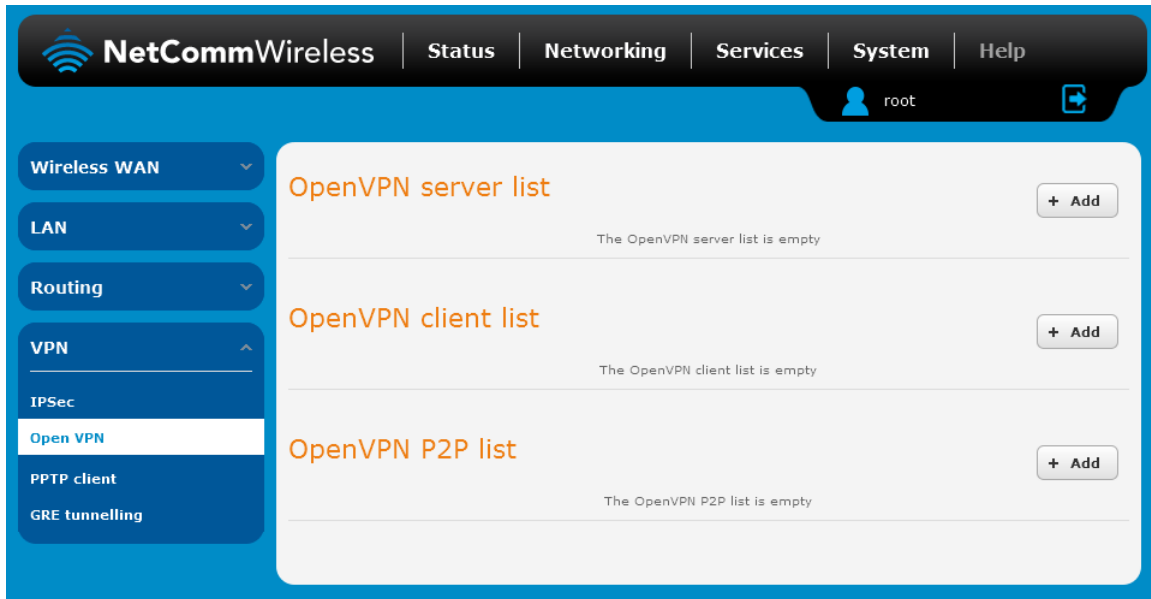
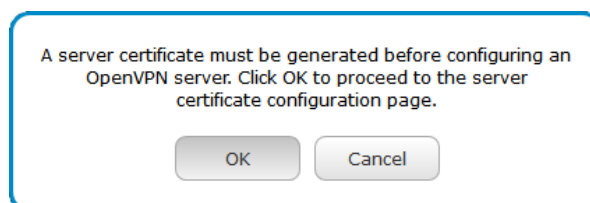

Figure 68 - OpenVPN VPN List

Click the **+Add** button for the type of OpenVPN server/client you would like to configure.

OpenVPN Server

When you select the **+Add** button to add an OpenVPN server, the router checks whether there are existing server certificates. If no server certificate is found, you are informed that you must generate a certificate before configuring the OpenVPN server.



Click on the **OK** button to be taken to the **Server certificate** page. For more information on generating server certificates, refer to the Server certificate section of this guide. When you have created the certificate, return to the OpenVPN server configuration page and continue with the steps below.

To configure an OpenVPN Server:

1. Click the **OpenVPN profile** toggle key to switch it to the **ON** position.
2. Type a name for the OpenVPN server profile you are creating.
3. In the **Type** drop down list, select the OpenVPN connection type (TUN/TAP). Default is **TUN**.
4. Use the **Server** port field to select a port number and then use the drop down list to select a packet type to use for your OpenVPN Server. The default OpenVPN port is 1194 and default packet type is UDP.

5. In the **VPN network address** and **VPN network subnet mask** fields, enter the IP address and network subnet mask to assign to your VPN. This is ideally an internal IP address which differs from your existing address scheme.
6. The **Server certificates** section displays the details of the certificate. If you wish to change the certificate, click the **Change** button.
7. HMAC or Hash-based Message Authentication Code is a means of calculating a message authentication code through the use of a cryptographic hash function and a cryptographic key. If you wish to use the HMAC signature as an additional key and level of security, under the SSL/TLS handshake section, click the **Use HMAC Signature** toggle key so that it is in the **ON** position, then click the **Generate** button so that the router can randomly generate the key. The Server key timestamp field is updated with the time that the key was generated. Click the **Download** button to download the key file so that it can be uploaded on the client.
8. Select an Authentication type. Authentication may be done using a **Certificate** or **Username / Password**.

Certificate Authentication

In the Certificate Management section, enter the required details to create a client certificate. All fields are required. When you have finished entering the details, click the **Generate** button.

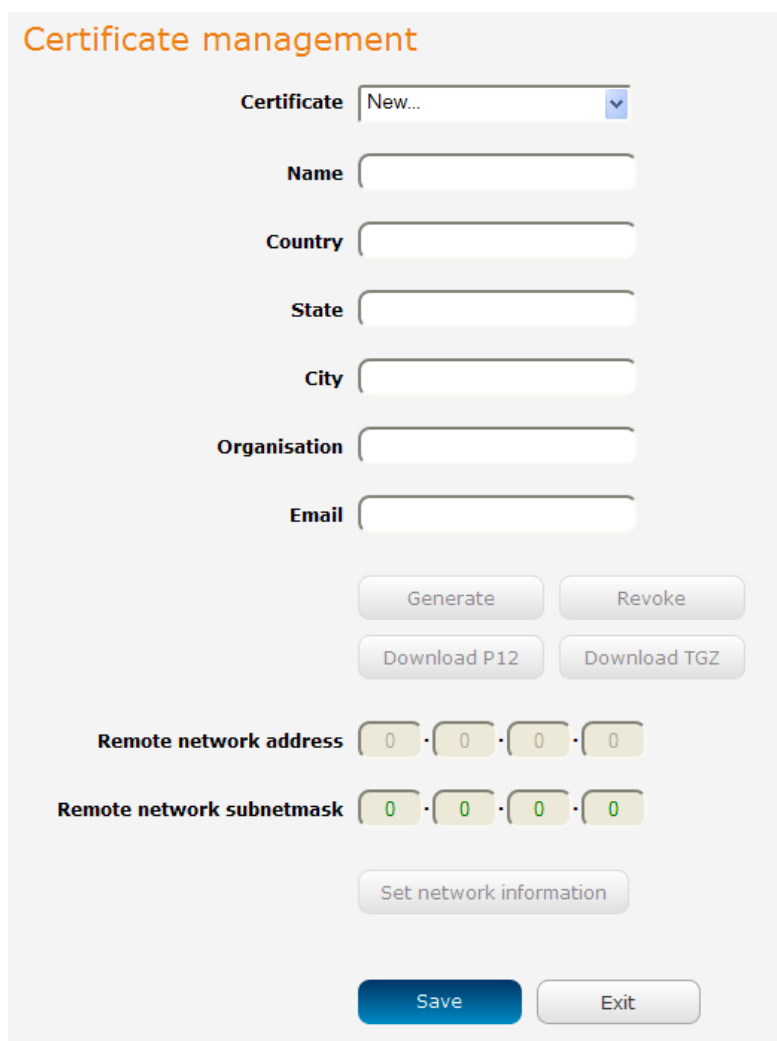

Figure 69 - OpenVPN server configuration – Certificate management

When it is done, you can click the **Download P12** button or the **Download TGZ** button to save the certificate file depending on which format you would like. If for some reason the integrity of your network has been compromised, you can return to this screen and use the Certificate drop down list to select the certificate and then press the **Revoke** button to disable it.

Optional: To inform the OpenVPN server of the network address scheme of the currently selected certificate, enter the network address and network subnet mask in the respective fields and click the **Set network information** button. If you do not enter the remote subnet here, any packet requests from the server to the client will not be received by the client network because it is not aware of the remote client's subnet.

OpenVPN server edit

OpenVPN profile ON

Profile name

Type TUN

Server port 1194 UDP

VPN network address . . .

VPN network subnet mask 255 . 255 . .

Server certificates

Not before Mar 13 04:21:03 2015 GMT

Not after Mar 10 04:21:03 2025 GMT

Country AU

State NSW

City Sydney

Organisation NetComm Wireless

Email techsupport@netcommwireless.com

Change

SSL/TLS handshake

Use HMAC Signature ON

Server key timestamp 2015-03-13 16:49:48

Generate

Download

Authentication type

Certificate Username / Password

Certificate management

Certificate New...

Name

Country

State

City

Organisation

Email

Generate

Revoke

Download P12

Download TGZ

Remote network address . . .

Remote network subnetmask . . .

Set network information

Save

Exit

Figure 70 – OpenVPN server profile settings

Username / Password Authentication

In the Username/Password section, enter the username and password you would like to use for authentication on the OpenVPN Server. Click the **Download CA certificate** or **Download CA TGZ depending on file format** button to save the **ca.crt** file. This file will need to be provided to the client.



Note: If you wish to have more than one client connect to this OpenVPN server, you must use Certificate authentication mode as Username/Password only allows for a single client connection.

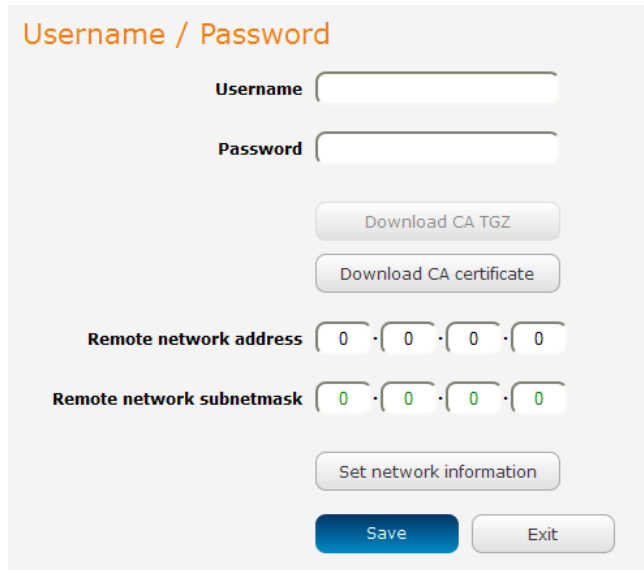

Figure 71 - OpenVPN Server – Username / Password section

Optional: To inform the OpenVPN server of the network address scheme of the currently selected certificate, enter the network address and network subnet mask in the respective fields and click the **Set Network Information** button. If you do not enter the remote subnet here, any packet requests from the server to the client will not be received by the client network because it is not aware of the remote client's subnet.

When you have finished entering all the required information, click **Save** to finish configuring the OpenVPN server.

Configuring an OpenVPN Client

1. Click the **OpenVPN profile** toggle key to switch it to the **ON** position.
2. In the **Profile name** field, type a name for the OpenVPN client profile you are creating.
3. In the **Server IP** address field, type the WAN IP address /host domain name of the OpenVPN server.
4. Select OpenVPN connection type (TUN/TAP). Default is **TUN**.
5. Use the **Server** port field to select a port number and then use the drop down list to select a packet type to use for the OpenVPN server. The default OpenVPN port is 1194 and default packet type is UDP.
6. If the **Default gateway** option is applied on the OpenVPN client page, the OpenVPN server will enable connections to be made to other client networks connected to it. If it is not selected, the OpenVPN connection allows for secure communication links between this router and the remote OpenVPN server only.
7. Use the **Authentication type** options to select the Authentication type that you would like to use for the OpenVPN client.

Certificate Authentication

In the Certificate upload section at the bottom of the screen, click the **Browse** button and locate the certificate file you downloaded when you configured the OpenVPN server. When it has been selected, click the **Upload** button to send it to the router.

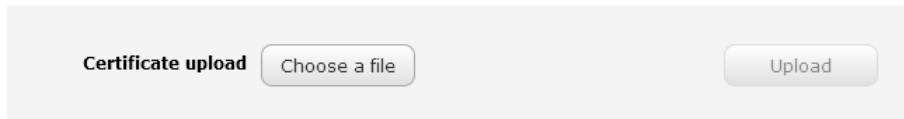

Figure 72 - OpenVPN client - Certificate upload

Username / Password Authentication

Enter the username and password to authenticate with the OpenVPN server.

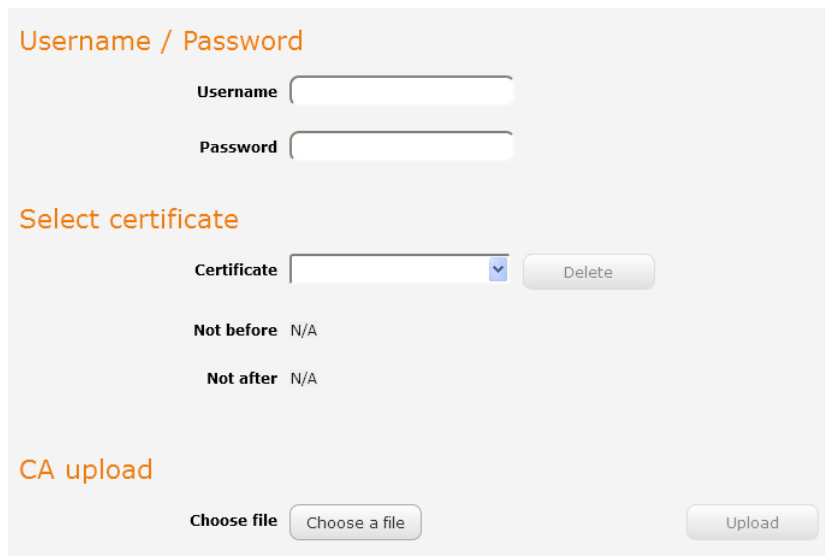

Figure 73 - OpenVPN Client - Username/Password section

Use the **Browse** button to locate the CA certificate file you saved from the OpenVPN Server and then press the **Upload** button to send it to the router.

Certificate and Username / Password Authentication

This is a combination of both the Certificate and Username / Password authentication methods providing additional levels of security since the client must know the username / password combination and be in possession of the certificate.

8. If you have an additional SSL/TLS key created on the server, click on the **Use HMAC Signature** toggle key so that it is in the **ON** position. Select the **Choose a file** button then locate the key file on your computer. Click the **Upload** button to upload it to the router.

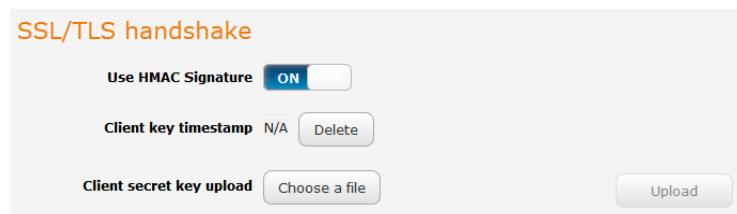

Figure 74 - OpenVPN Client - SSL/TLS key upload

9. Click the **Save** button to complete the OpenVPN Client configuration.

Configuring an OpenVPN P2P Connection

To configure an OpenVPN peer-to-peer connection:

1. Set the **OpenVPN** profile toggle key to switch it to the **ON** position.
2. In the **Profile name** field, type a name for the OpenVPN P2P profile you are creating.
3. On the router designated as the server, leave the **Server IP address** field empty. On the router designated as the client, enter the **WAN IP address/host domain name** of the server.

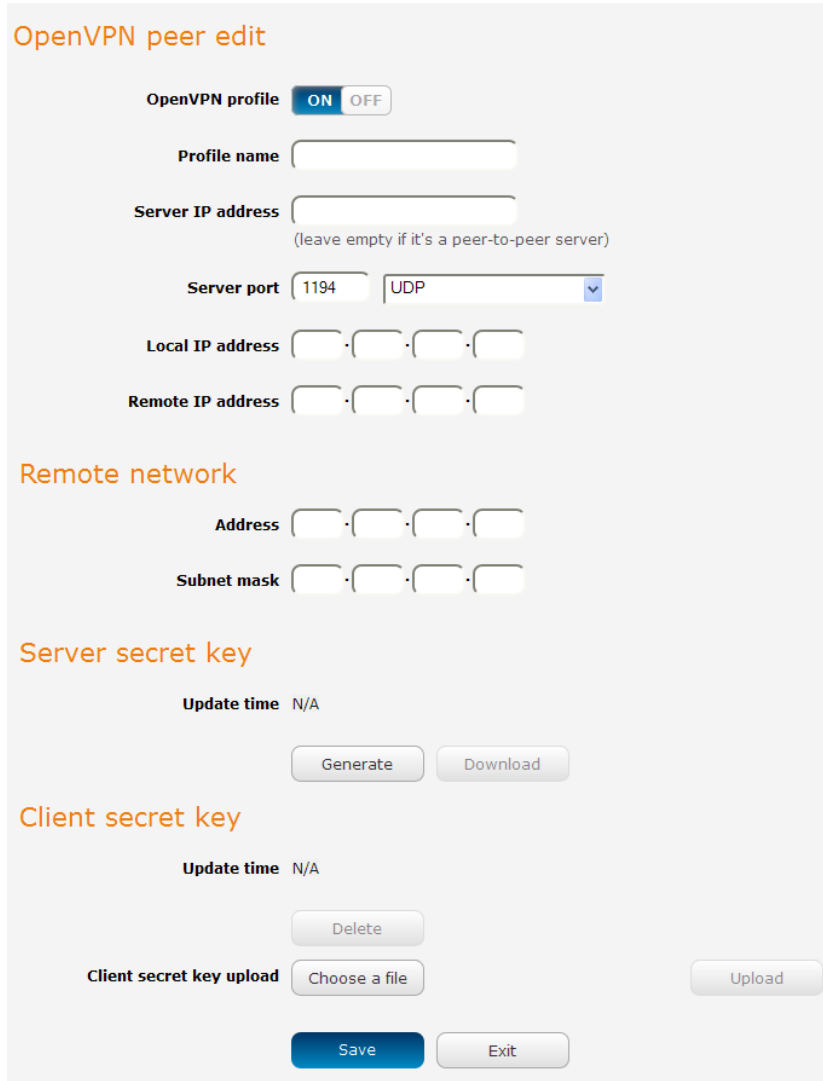

Figure 75 - OpenVPN P2P mode settings

4. Use the **Server** port field to select a port number and then use the drop down list to select a packet type to use for the OpenVPN server. The default OpenVPN port is 1194 and default packet type is UDP.
5. In the **Local IP Address** and **Remote IP Address** fields, enter the respective local and remote IP addresses to use for the OpenVPN tunnel. The slave should have the reverse settings of the master.
6. Under the Remote network section, enter the network **Address** and network **Subnet mask**. The Network Address and Network Mask fields inform the Master node of the LAN address scheme of the slave.
7. Press the **Generate** button to create a secret key to be shared with the slave. When the timestamp appears, you can click the **Download** button to save the file to exchange with the other router.
8. When you have saved the secret key file on each router, use the **Browse** button to locate the secret key file for the master and then press the **Upload** button to send it to the slave. Perform the same for the other router, uploading the slave's secret key file to master.
9. When they are uploaded click the **Save** button to complete the peer-to-peer OpenVPN configuration.

PPTP-Client

The Point-to-Point Tunneling Protocol (PPTP) is a method for implementing virtual private networks using a TCP and GRE tunnel to encapsulate PPP packets. PPTP operates on Layer 2 of the OSI model and is included on Windows computers.

Configuring the PPTP Client

To configure the PPTP client:

1. From the menu bar at the top of the screen, click **Networking** and then from the **VPN** section on the left side of the screen, click **PPTP client**. The PPTP client list is displayed.

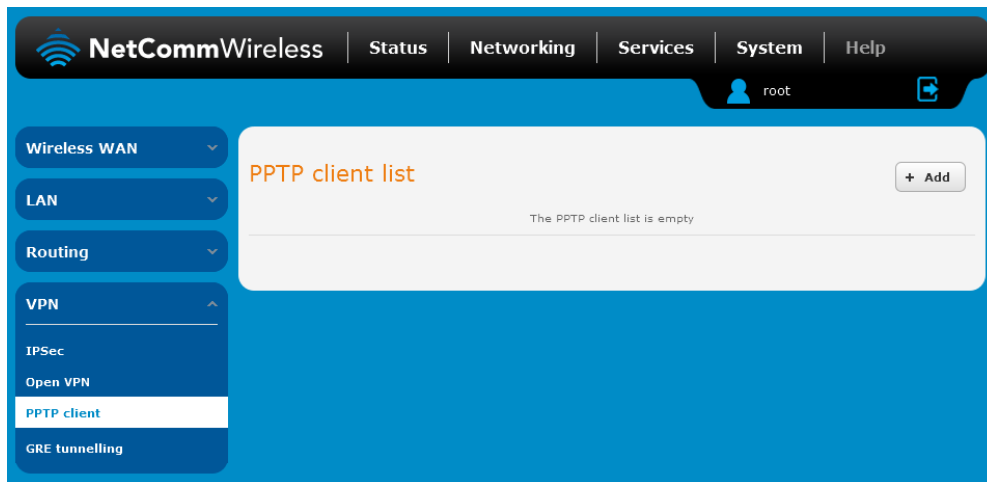

Figure 76 - PPTP client list

2. Click the **+Add** button to begin configuring a new PPTP client profile. The PPTP client edit screen is displayed.

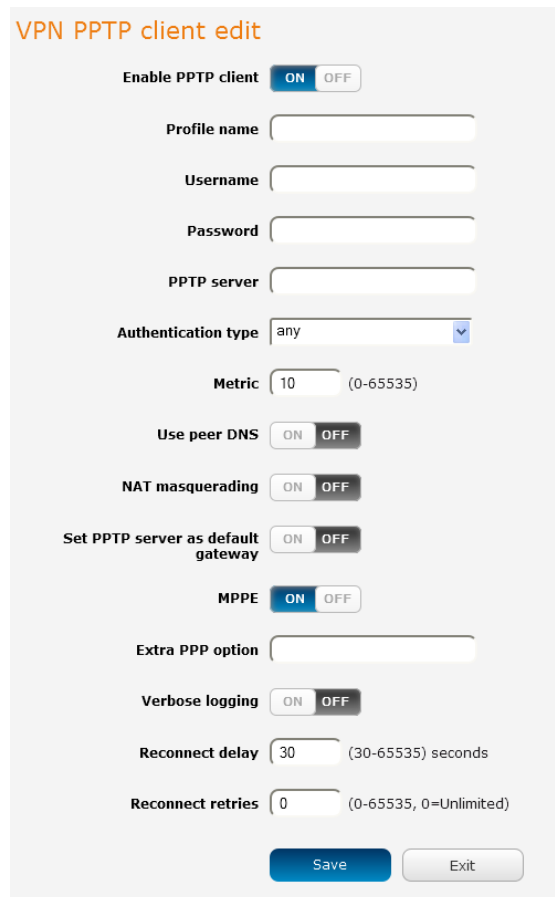

Figure 77 - VPN PPTP client edit

3. Click the **Enable PPTP client** toggle key to switch it to the **ON** position.
4. In the **Profile name list**, enter a profile name for the tunnel. This may be anything you like and is used to identify the tunnel on the router.
5. Use the **Username** and **Password** fields to enter the username and password for the PPTP account.
6. In the **PPTP server address** field, enter the IP address /host domain name of the PPTP server.
7. From the **Authentication type** drop down list, select the Authentication type used on the server. If you do not know the authentication method used, select **any** and the router will attempt to determine the correct authentication type for you. There are 5 authentication types you can choose from:
 - 📶 CHAP – uses a three way handshake to authenticate the identity of a client.
 - 📶 MS-CHAP v1 – This is the Microsoft implementation of the Challenge Handshake Authentication Protocol for which support was dropped in Windows® Vista.
 - 📶 MS-CHAP v2 - This is the Microsoft implementation of the Challenge Handshake Authentication Protocol which was introduced in Windows® NT 4.0 and is still supported today.
 - 📶 PAP – The Password Authentication Protocol uses a password as a means of authentication and as such, is commonly supported. PAP is not recommended because it transmits passwords unencrypted and is not secure.
 - 📶 EAP – Extensible Authentication Protocol. An Authentication protocol commonly used in wireless networks.
8. The **metric** value helps the router to prioritise routes and must be a number between 0 and 65535. The default value is 30 and should not be modified unless you are aware of the effect your changes will have.
9. The **Use peer DNS** option allows you to select whether the remote clients will use the Domain Name Server of the PPTP server. Click the toggle key to set this to ON or OFF as required.
10. **NAT masquerading** allows the router to modify the packets sent and received to inform remote computers on the internet that packets originating from a machine behind the router actually originated from the WAN IP address of the router's internal NAT IP address. Click the toggle key to switch this to the ON position if you want to use this feature.
11. **Set default route to PPTP** sets all outbound data packets to go out through the PPTP tunnel. Click the toggle key to switch this to the ON position if you want to use this feature.
12. The **MPPE** toggle key selects whether the router uses the Microsoft Point to Point Encryption protocol. NetComm Wireless routers support up to 128-bit encryption using the MPPE protocol.
13. The **Verbose logging** option sets the router to output detailed logs regarding the PPTP connection in the **System Log** section of the router interface.
14. The **Reconnect delay** is the time in seconds that the router will wait before attempting to connect to the PPTP server in the event that the connection is broken. The minimum time to wait is 30 seconds so as to not flood the PPTP server with connection requests, while the maximum time to wait is 65535 seconds.
15. The **Reconnect retries** is the number of connection attempts that the router will make in the event that the PPTP connection goes down. If set to 0, the router will retry the connection indefinitely, otherwise the maximum number of times to retry cannot be greater than 65535.
16. Click the **Save** button to save the changes. The VPN will attempt to connect after your click Save. Click the **Status** button at the top left of the interface to return to the status window and monitor the VPN's connection state.

GRE tunnelling

The Generic Route Encapsulation (GRE) protocol is used in addition to Point-to-Point Tunnelling Protocol (PPTP) to create VPNs (virtual private networks) between clients and servers or between clients only. Once a PPTP control session establishes the VPN tunnel GRE is used to securely encapsulate the data or payload.

Configuring GRE tunnelling

To configure GRE tunnelling:

1. From the menu bar at the top of the screen, click **Networking** and then from the **VPN** section on the left side of the screen, click **GRE**. The GRE client list is displayed.

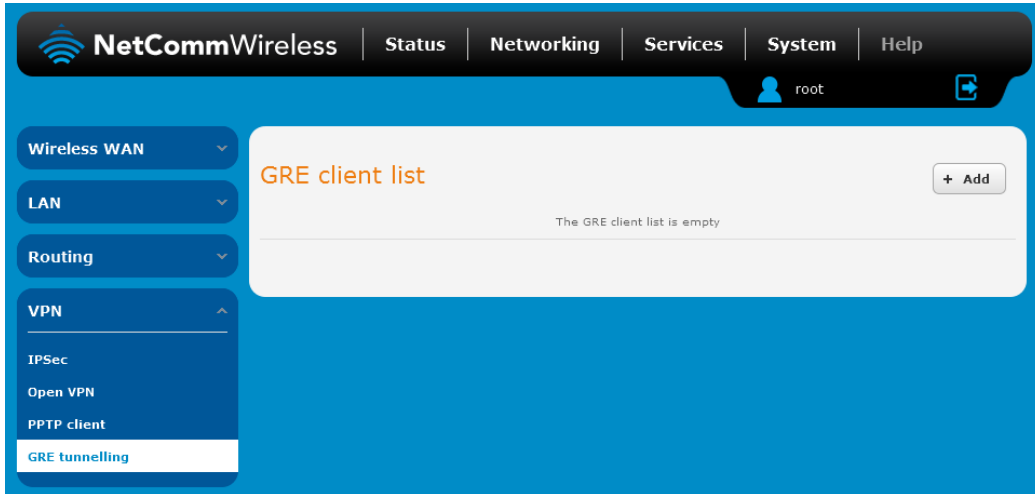

Figure 78 - GRE client list

2. Click the **+Add** button to begin configuring a new GRE tunnelling client profile. The GRE Client Edit screen is displayed.

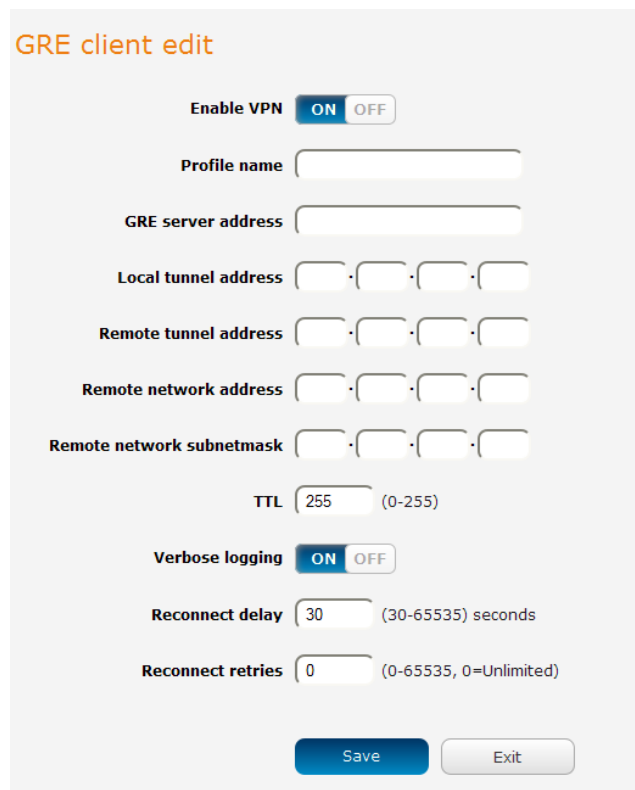

Figure 79 – GRE client edit

3. Click the **Enable GRE Tunnel** toggle key to switch it to the **ON** position.

4. In the **Profile name**, enter a profile name for the tunnel. This may be anything you like and is used to identify the tunnel on the router.
5. In the **GRE server address** field, enter the IP address or domain name of the GRE server.
6. In the **Local tunnel address** field, enter the IP address you want to assign the tunnel locally.
7. In the **Remote tunnel address** field, enter the IP address you want to assign to the remote tunnel.
8. In the **Remote network address** field, enter the IP address scheme of the remote network.
9. In the **Remote network subnetmask** field, enter the subnet mask of the remote network.
10. The **TTL** (Time To Live) field is an 8-bit field used to remove an undeliverable data packet from a network to avoid unnecessary network traffic across the internet. The default value of 255 is the upper limit on the time that an IP datagram can exist. The value is reduced by at least one for each hop the data packet takes to the next router on the route to the datagram's destination. If the TTL field reaches zero before the datagram arrives at its destination the data packet is discarded and an error message is sent back to the sender.
11. The **Verbose logging** option sets the router to output detailed logs regarding the GRE tunnel in the **System Log** section of the router interface.
12. The **Reconnect delay** is the time in seconds that the router will wait before attempting to connect to the GRE server in the event that the connection is broken. The minimum time to wait is 30 seconds so as to not flood the GRE server with connection requests, while the maximum time to wait is 65335 seconds.
13. The **Reconnect retries** is the number of connection attempts that the router will make in the event that the GRE connection goes down. If set to 0, the router will retry the connection indefinitely, otherwise the maximum number of times to retry cannot be greater than 65335.
14. Click the **Save** button to save the changes. The VPN will attempt to connect after your click Save. Click the **Status** button at the top left of the interface to return to the status window and monitor the VPN's connection state.

Services

Dynamic DNS

The DDNS page is used to configure the Dynamic DNS feature of the router. A number of Dynamic DNS hosts are available from which to select.



Figure 80 – Dynamic DNS settings

Dynamic DNS provides a method for the router to update an external name server with the current WAN IP address.

To configure dynamic DNS:

1. Click the **DDNS configuration** toggle key to switch it to the ON position.
2. From the **Dynamic DNS** drop down list, select the Dynamic DNS service that you wish to use. The available DDNS services available are:
 - www.dhs.org
 - www.dyndns.org
 - www.dyns.cx
 - www.easydns.com
 - www.justlinux.com
 - www.ods.org
 - www.tzo.com
 - www.zoneedit.com
3. Enter your hostname in 'Host name' field.
4. In the **Username** and **Password** fields, enter the logon credentials for your DDNS account. Enter the password for the account again in the **Verify password** field.
5. Click the **Save** button to save the DDNS configuration settings.

Network time (NTP)

The NTP (Network Time Protocol) settings page allows you to configure the NTC-6200 Series router to synchronize its internal clock with a global Internet Time server and specify the time zone for the location of the router. This provides an accurate timekeeping function for features such as System Log entries and Firewall settings where the current system time is displayed and recorded.

Any NTP server available publicly on the internet may be used. The default NTP server is 0.netcomm.pool.ntp.org.

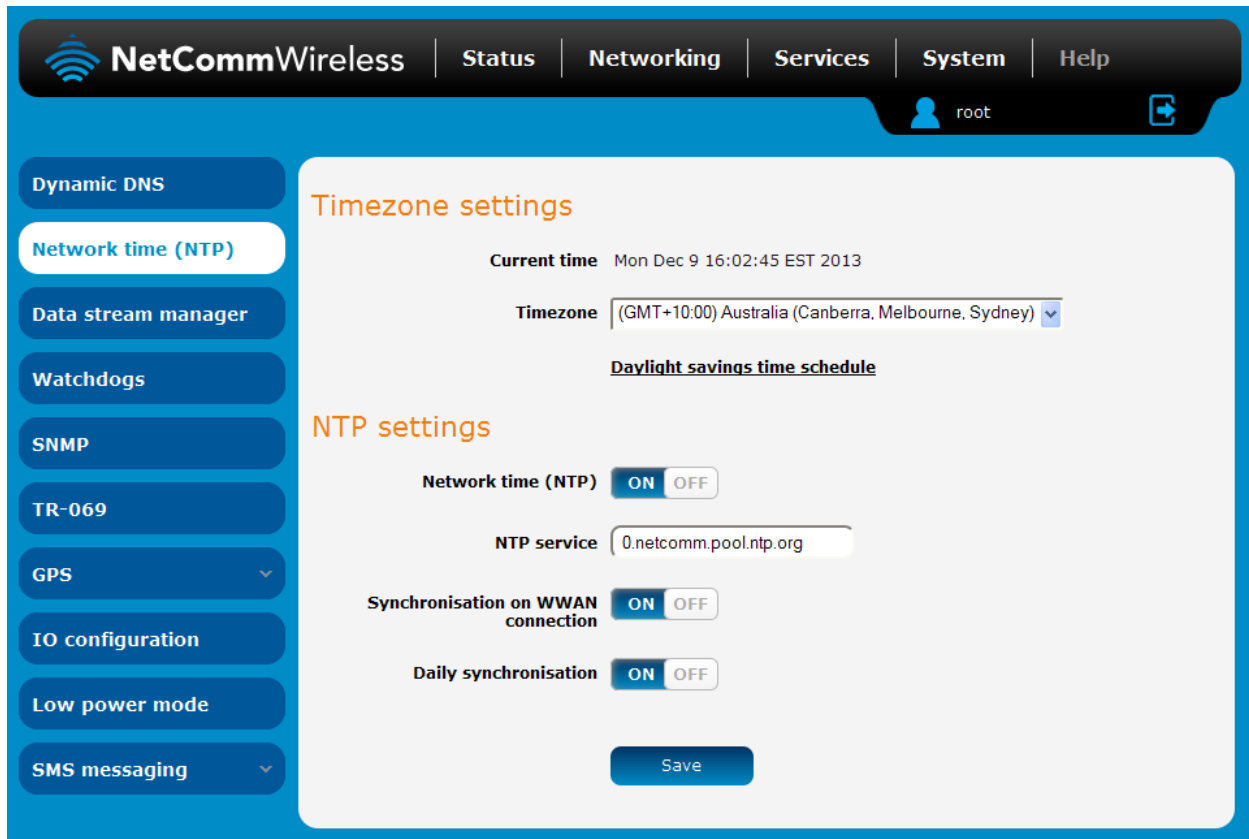

Figure 81 - NTP settings

Configuring Timezone settings

To configure time zone settings:

1. The **Current time** field shows the time and date configured on the router. If this is not accurate, use the **Time zone** drop down list to select the correct time zone for the router. If the selected zone observes daylight savings time, a **Daylight savings time schedule** link appears below the drop down list. Click the link to see the start and end times for daylight savings.
2. When you have selected the correct time zone, click the **Save** button to save the settings.

Configuring NTP settings

To configure NTP settings:

1. Click the **Network time (NTP)** toggle key to switch it to the **ON** position.
2. In the **NTP service** field, enter the address of the NTP server you wish to use.
3. The **Synchronization on WWAN connection** toggle key enables or disables the router from performing a synchronization of the time each time a mobile broadband connection is established.
4. The **Daily synchronisation** toggle key enables or disables the router from performing a synchronization of the time each day.
5. When you have finished configuring NTP settings, click the **Save** button to save the settings.

Data stream manager















The data stream manager provides you with the ability to create mappings between two endpoints on the router. These endpoints may be physical or virtual, for example, a serial port connected to the router’s USB port could be configured as an endpoint or you could configure a TCP Server as an endpoint. You can then configure a virtual data tunnel or “stream” between the endpoints.

The data stream manager provides a wide range of possibilities and expands upon simple PAD functionality to include the forwarding and translation of data between any of the endpoints. For example, you could send the GPS data from the built-in module to a TCP server running on the router. In each case, the logical flow of the stream is from Endpoint A to Endpoint B.

Customers interested in developing their own applications to create custom endpoints and streams can contact NetComm Wireless about our Software Development Kit.

Endpoints

The first thing to be done in order to create a data stream is to define the endpoints. There are 14 types of endpoint that may be configured:

-  Serial port (generic)
-  TCP Server
-  TCP Client
-  UDP Server
-  UDP Client
-  GPS Data (for devices with GPS receiver)
-  User defined executable
-  RS232 port
-  RS485 port
-  RS422 port
-  Modem emulator
-  PPP server
-  IP modem
-  Circuit switched data (CSD)
-  TCP connect-on-demand

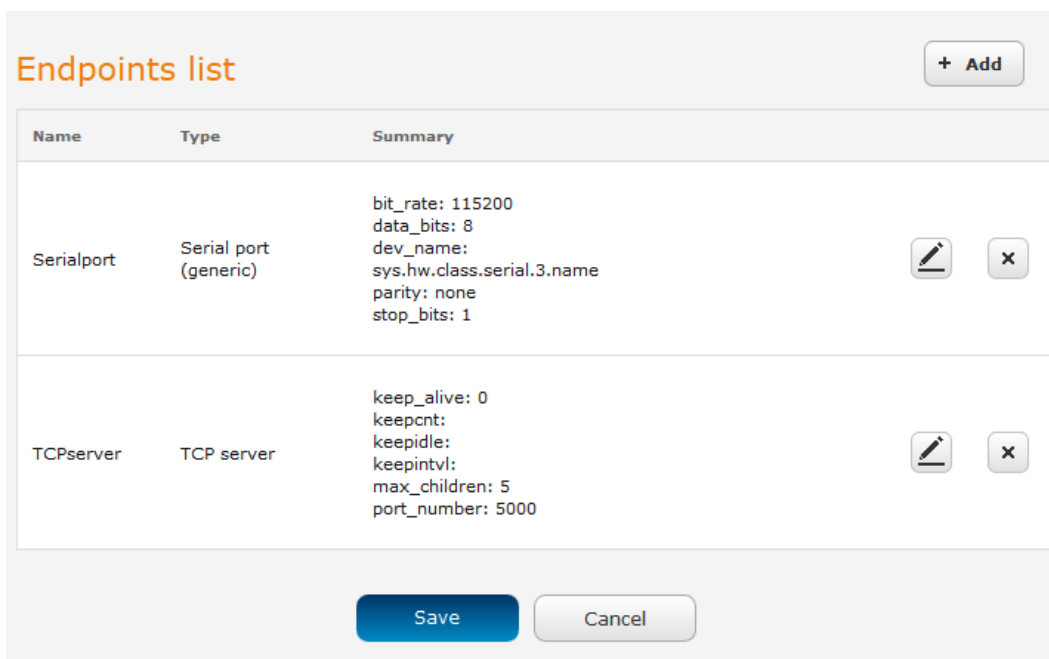

Figure 82 - Endpoints list

Serial port (generic)

This creates a generic serial port as an endpoint defaulting to the commonly used settings as shown below.

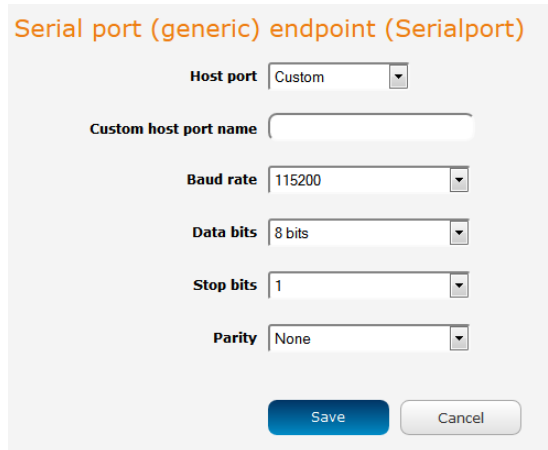

Figure 83 - Serial port (generic) endpoint configuration (Custom)

When the Host port is set to **Custom**, you can use the **Custom host port name** field to manually specify a device path to use, for example, if using a USB-to-Serial adapter you could telnet to the router and issue the command `ls /dev/ttyUSB*` to list the paths of the connected USB devices. To determine the path of the desired USB adapter, issue the command when the adapter is not connected then run the command again when the adapter is connected and compare the output.



Note: Using a custom host port name is not recommended for normal use as the device path can change between power cycles of the router.

TCP server

This creates a TCP server endpoint with the following options available.

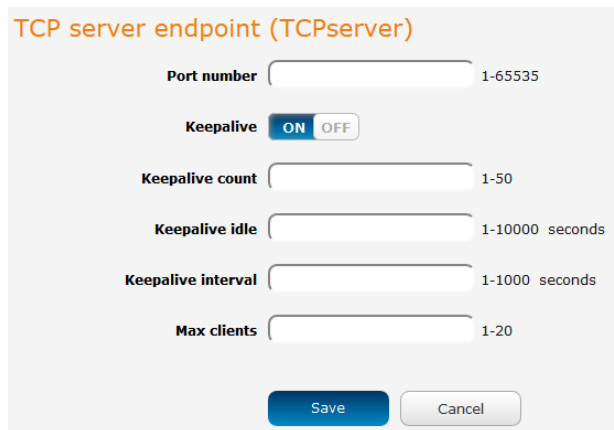

Figure 84 - TCP server endpoint configuration

ITEM	DESCRIPTION
Port number	The port number that the TCP server operates on.
Keepalive	Keepalive sends a message to check that the link is still active or to keep it active.
Keepalive count	The number of keepalive messages to send.
Keepalive idle	The duration between two keepalive transmissions when in idle condition.
Keepalive interval	The duration between two successive keepalive retransmissions.
Max clients	The maximum number of clients that may connect to this TCP server.

Table 21 – TCP server endpoint options

TCP client

This creates a TCP client endpoint with the following options available. The retry timeout period specifies the number of seconds to wait between attempts to re-establish a connection in the event that it is lost. The client will attempt re-connection indefinitely every Retry timeout interval.

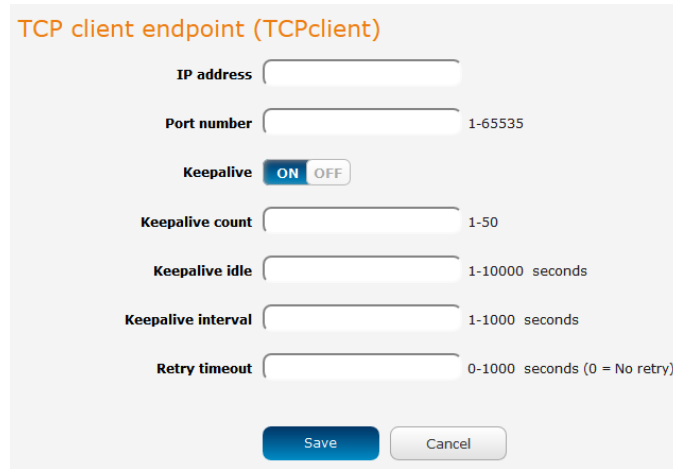

TCP client endpoint (TCPclient)

IP address

Port number 1-65535

Keepalive ON OFF

Keepalive count 1-50

Keepalive idle 1-10000 seconds

Keepalive interval 1-1000 seconds

Retry timeout 0-1000 seconds (0 = No retry)

Figure 85 - TCP client endpoint configuration

ITEM	DESCRIPTION
IP address	The IP address of the TCP server that the client connects to.
Port number	The port number that the TCP server operates on.
Keepalive	Keepalive sends a message to check that the link is still active or to keep it active.
Keepalive count	The number of keepalive messages to send.
Keepalive idle	The duration between two keepalive transmissions when in idle condition.
Keepalive interval	The duration between two successive keepalive retransmissions.
Retry timeout	The retry timeout period specifies the number of seconds to wait between attempts to re-establish a connection in the event that it is lost.

Table 22 – TCP client endpoint options

UDP server

This creates a UDP server endpoint with the following options available.

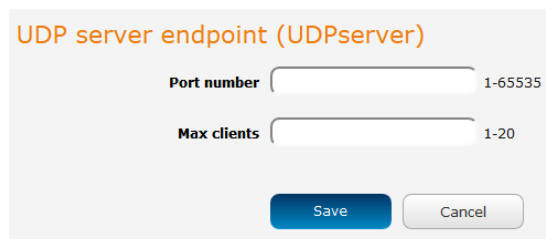

UDP server endpoint (UDPserver)

Port number 1-65535

Max clients 1-20

Figure 86 - UDP server endpoint configuration

UDP client

This creates a UDP client endpoint with the following options available. The retry timeout period specifies the number of seconds to wait between attempts to re-establish a connection in the event that it is lost. The client will attempt re-connection indefinitely every Retry timeout interval.

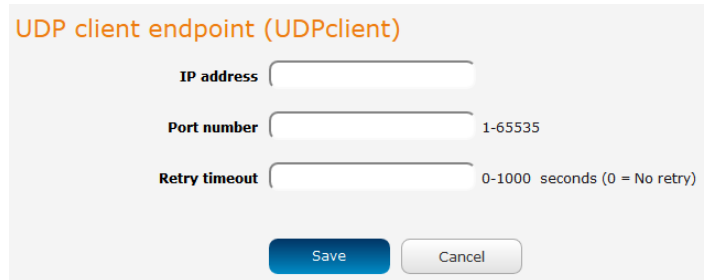

Figure 87 - UDP client endpoint configuration

GPS data

This creates a GPS data endpoint.



Note: You must have GPS enabled before you can create this endpoint.



Figure 88 - GPS data endpoint configuration

User defined executable

Allows you to specify an executable and parameters to be used as an endpoint. For example, the following executable reads the phone module temperature every second.

```
while true; do rdb_get wwan.0.radio.temperature; sleep 1; done
```

The temperature can then be sent to another endpoint.



Figure 89 - User defined executable endpoint configuration

RS232 / RS485 / RS422 port

These endpoint types all use the built-in serial port. When one of these endpoints is used to create a stream, the necessary hardware switches to accommodate the chosen serial communication interface are made.

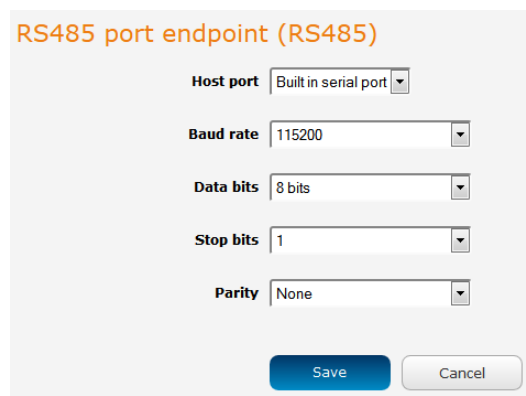

Figure 90 - RS232 / RS485 / RS422 port configuration options

Modem emulator

Modem emulator allows you to connect legacy equipment such as an RTU or PLC to the serial port of the router in place of a traditional dial-up modem. The NTC-6200 series router emulates the dial-up modem's behaviour and passes the serial data over the IP network.

Modem emulator endpoint (modememulator)

Host port

Baud rate

Data bits

Stop bits

Parity

Hardware flow control

Software flow control

DSR action

DCD action

DTR action

RI action

Enable auto answer ON OFF

Circuit auto answer rings

^ **Advanced status**

Echo enable ON OFF

Quiet mode ON OFF

Send OK on carriage return ON OFF

Suppress line feeds ON OFF

Send OK on unknown command ON OFF

Verbose mode ON OFF

Figure 91 - Modem emulator endpoint configuration

ITEM	DESCRIPTION
Host port	Use the drop down list to select the serial port to use. If no USB-to-Ethernet adapter is connected, the only available selection is the Built-in serial port.
Baud rate	The serial (V.24) port baud rate. By default the serial line format is 8 data bits, No parity, 1 Stop bit. Refer to the AT (V.250) AT Command Manual if you need to change the serial line format.
Data bits	The default serial line data bits setting used is 8. Options include 5 – 8 bits.
Stop bits	The default stop bit setting is set to 1. However the stop bit setting can be set to 2 bits if required.
Parity	Parity is the means to detect transmission errors. An extra data bit is transmitted with each data character, and is arranged in a fashion such that the number of 1 bits in each character, including the parity bit, is always odd or always even. If a byte is received with the wrong number of 1s, then this shows the data must be corrupt. Options include none, odd or even. The default setting is none for no parity checks.
Hardware flow control	<ul style="list-style-type: none"> • Off - Serial port flow control off • Hardware - Serial port uses RTS/CTS flow control
Software flow control	Enables or disables software flow control.
DSR action	<p>Sets the Data Set Ready action. This is an output from the modem and this configuration determines the pin's behavior.</p> <ul style="list-style-type: none"> • Always: DSR is always on. • Registered: When connected to a CSD endpoint, sets pin to "on" when modem is in data mode. • Session established: When connected to PPP endpoint, sets pin on when PDP is connected, when connected to IP modem endpoint, sets pin to on when modem is in online state (e.g. data connection is established). • Never: DSR is always off. • Mimic DTR: mimics the DTR pin.
DCD action	<p>Determines how the router controls the state of the serial port Data Carrier Detect (DCD) line.</p> <ul style="list-style-type: none"> • Always On: DCD is always on. • Connect: DCD is on when a connection is established in response to an ATD command or DTR dial. • Session established: Pin is on when PPP session is in progress or modem is in an online state (e.g. data connection is established). • Always Off: DCD is always off.
DTR action	<p>Determines how the router responds to change of state of the serial port DTR line</p> <ul style="list-style-type: none"> • Ignore - Take no action • Enter Command State – when connected to PPP endpoint, this is equivalent to disconnect. When connected to IP modem or CSD endpoint, this enters online command state (e.g. process AT commands without dropping the connection). • Disconnect – terminates connection.
RI action	<p>Determines how the router controls the state of the serial port RI (Ring Indicator) line.</p> <ul style="list-style-type: none"> • Always On: RI is always on. • Incoming Ring: RI is on when an incoming connection request is received. • Always Off: RI is always off
Enable auto answer	When enabled, the router accepts incoming connections.
Circuit auto answer rings	Sets the number of incoming rings after which the router will answer incoming circuit switched data calls. The default value is Off. The other available options are from 1 to 12.
Advanced status	
Echo enable	Enables echo on the serial side. All commands are echoes. This can be turned on/off via ATE1 and ATE0 commands. Recommended setting for this option is ON.
Quiet mode	When on, there is no output from the modem on the serial side, i.e. you do not see OK, Connect etc. Recommended setting for this option is OFF.
Send OK on carriage return	If enabled, will print OK every time CR is received on the serial side. Recommended setting for this option is ON.
Suppress line feeds	If enabled, line termination is using CR (13). If disabled, line termination is CR LF (13 10). Recommended setting for this option is OFF.
Send OK on unknown command	Will send OK when an unknown/invalid AT command is received. Recommended setting for this option is ON.
Verbose mode	The modem returns messages to the computer to indicate the return status of commands and interrupts such as incoming call and call progress. Recommended setting for this option is ON.

Table 23 - Modem emulator endpoint options

PPP server

This creates a point-to-point server endpoint with the following options.

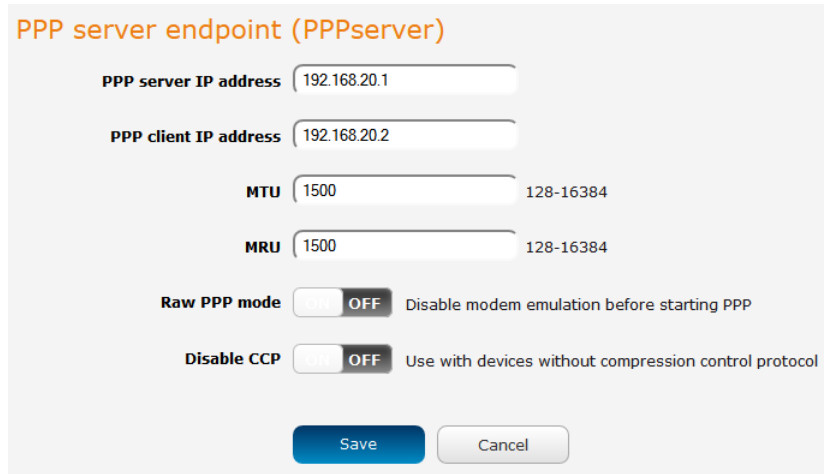

PPP server endpoint (PPPserver)

PPP server IP address

PPP client IP address

MTU 128-16384

MRU 128-16384

Raw PPP mode ON OFF Disable modem emulation before starting PPP

Disable CCP ON OFF Use with devices without compression control protocol

Figure 92 - PPP server endpoint configuration

ITEM	DESCRIPTION
PPP server IP address	The IP address of the PPP server. This defaults to the router's current IP address.
PPP client IP address	The IP address of the PPP client. This defaults to the next IP address in the DHCP range after the router's address.
MTU	The maximum transmission unit size of packets sent by the PPP server.
MRU	The maximum receive unit size of packets received by the PPP server.
Raw PPP mode	This option is provided for compatibility with legacy devices that assume there is a line available and do not require dial commands to be issued first. Raw PPP mode is turned off by default.
Disable CCP	This option is provided for use with devices that do not support the compression control protocol. The router uses the compression control protocol and the toggle key is in the OFF position by default.

Table 24 - PPP server endpoint options

IP modem

This endpoint can be used to connect to the modem emulator endpoint to achieve similar functionality to PAD Daemon. It allows a data stream from the serial port to a TCP/UDP server/client and provides modem control lines and AT interpreter on the serial side.

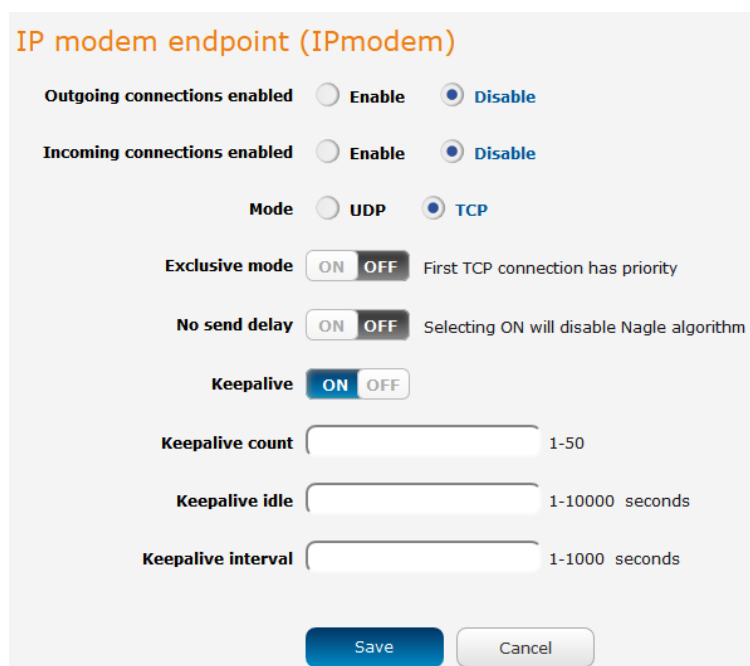

IP modem endpoint (IPmodem)

Outgoing connections enabled Enable Disable

Incoming connections enabled Enable Disable

Mode UDP TCP

Exclusive mode ON OFF First TCP connection has priority

No send delay ON OFF Selecting ON will disable Nagle algorithm

Keepalive ON OFF

Keepalive count 1-50

Keepalive idle 1-10000 seconds

Keepalive interval 1-1000 seconds

Table 25 - IP modem endpoint configuration

ITEM	DESCRIPTION
Outgoing connections enabled	Enables or disables the ability of the router to initiate outbound network connections i.e act as a networking client. It will attempt to connect to the remote server when relevant activity is detected on the serial side e.g. ATD dial command.
Incoming connections enabled	Enables or disables the ability of the router to accept incoming network connections i.e. act as a networking server. When an incoming connection from a remote client is detected, the router simulates a dial-in call on the serial line.
Mode	Sets the IP modem to either TCP or UDP mode.
Exclusive mode (TCP mode only)	When this is off, any new client connection disconnects the previous client connection and uses a new client instead.
No send delay	Disables Nagle algorithm. Disabling this is sometimes important so that serial data is sent as soon as possible instead of waiting for a more optimal block of data for Ethernet. Enabling this effectively reduces latency but increases the amount of network traffic.
Keepalive	Keepalive sends a message to check that the link is still active or to keep it active.
Keepalive count	The number of keepalive messages to send.
Keepalive idle	The duration between two keepalive transmissions when in idle condition.
Keepalive interval	The duration between two successive keepalive retransmissions.

Table 26 – IP modem endpoint options

Circuit switched data (CSD)

The CSD (Circuit Switched Data) endpoint is designed for use when CSD connectivity is required between equipment connected through NetComm Wireless routers. A typical application of CSD is a dial-up connection to an ISDN service. CSD calls use the functionality of the GSM networking and switching subsystem to carry data via GSM or later cellular networks.

In many ways, this is similar to making a voice call. When a CSD connection is established, the communication end points are connected via a virtual circuit, similar to connections on traditional phone network. Unlike other end points connected to a Modem emulator end point, CSD relies mainly on the functionality of 3G/4G/LTE module. In CSD mode, the data stream of the router transparently passes through the data and signals from the serial port to the module and vice-versa. The available data rates will vary according to the network of the service provider. It is not necessary to have PDP profiles enabled for this functionality, however, you may need a special SIM card with data functionality for CSD calls to be made. Check with your service provider.

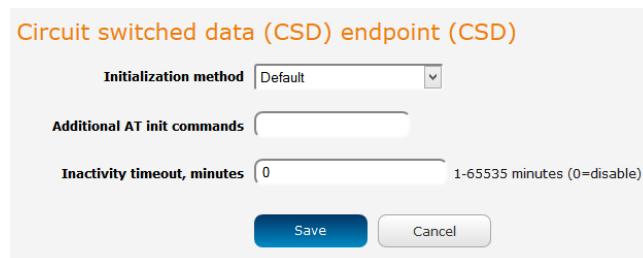

Figure 93 – Circuit switched data endpoint configuration

ITEM	DESCRIPTION
Initialization method	Default - when data stream is established, the module will be initialized to a well-known, safe configuration appropriate for CSD connection. These include the following AT commands: ATE1 - enable echo ATQ0 - disable quiet mode ATV1 - enable verbose mode AT&D2 - DTR line inactive disconnects the calls AT&S1 - DSR becomes active in data mode, and off in command mode AT&C1 - CD becomes active when call is connected Hardware flow control is enabled on the module User: no pre-defined commands are sent to the module. Custom initialization can be done using "Additional AT init commands"
Additional AT initialization commands	These commands are sent after default commands (if default method is used). For example, to change DTR operation to enter online command mode instead of default disconnect, use the following command: AT&D1 with "Default" initialization method.
Inactivity timeout	If a non-zero value is entered and the router detects an inactivity period in an established CSD call in excess of the number of minutes entered, the CSD call will be automatically terminated. Note: data sent in any direction will prevent the call from being disconnected. The specified value should be in minutes.

Table 27 – CSD endpoint options

TCP connect-on-demand endpoint

The TCP connect-on-demand endpoint allows data to be buffered and then sent to a TCP server when the buffer has been filled. It is primarily useful in situations where you do not want 'keep alive' packets to keep the socket open and create an overhead when the TCP data connection is not in use.

TCP connect-on-demand endpoint (TCP_COD)

Primary server IP address

Port number 1-65535

Backup server IP address Leave blank if backup server not required

Port number 1-65535

Inactivity timeout 0-10000 seconds, 0 Disconnect immediately

Minimum transmit buffer size 1-1500

Start ID Send this ID to server when connected

End ID Send this ID to server before disconnecting

Keepalive ON OFF

Keepalive count 1-50

Keepalive idle 1-10000 seconds

Keepalive interval 1-1000 seconds

Figure 94 – TCP connect-on-demand endpoint configuration

ITEM	DESCRIPTION
Primary server IP address	The IP address of the TCP server to which the router should attempt the initial connection.
Port number	The port number that the TCP server operates on.
Backup server IP address	If connection to the primary server fails, the router will attempt to connect to this address.
Port number	The port number that the backup TCP server operates on.
Inactivity timeout	The period, in seconds, that the socket is considered idle/inactive if no packets are sent. The timer begins at the end of the last sent packet. The valid range is 0-10000 seconds. If this field is set to 0, the client disconnects immediately after sending a packet.
Minimum transmit buffer size	The number of bytes that must be reached before the client decides to transmit.
Start ID	This is a string which, if configured, is sent before any serial data is sent, every time the client connects <START ID><SERIAL DATA>
End ID	This is a string which, if configured, is sent after all serial data, just before the client disconnects <START ID><SERIAL DATA><END ID>
Keepalive	Keepalive sends a message to check that the link is still active or to keep it active.
Keepalive count	The number of keepalive messages to send.
Keepalive idle	The duration between two keepalive transmissions when in idle condition.
Keepalive interval	The duration between two successive keepalive retransmissions.

Table 28 – TCP connect-on-demand endpoint options

To create an endpoint:

1. Click the **+Add** button on the right side of the page. A pop-up window appears.

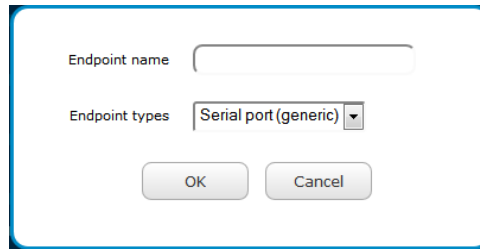
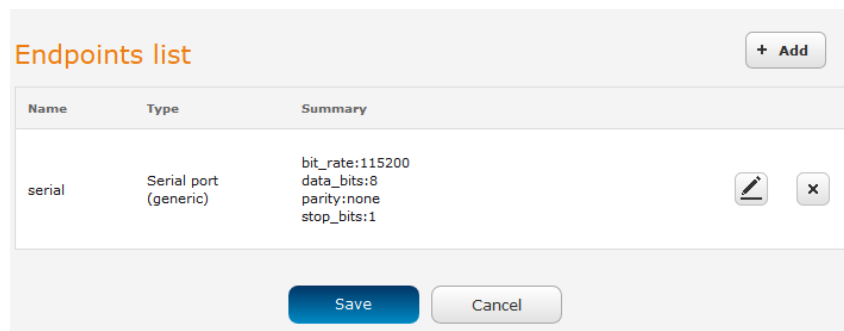

Figure 95 - Creating an endpoint

2. In the **Endpoint name** field, type a name for this endpoint. The name can contain alphanumeric characters only i.e. A-Z, a-z, 0-9.
3. Use the **Endpoint types** drop down list to select the type of endpoint to configure.
4. Click the **OK** button. The router displays a screen with configuration options for your chosen endpoint type. Enter the options for your endpoint as required.
5. Click the Save button. The Endpoints list is displayed with the newly created endpoint listed and a summary of the settings your configured.



Name	Type	Summary
serial	Serial port (generic)	bit_rate:115200 data_bits:8 parity:none stop_bits:1

Figure 96 - Endpoints list

Streams

When you have created the required endpoints, you can then proceed to set up a data stream. A data stream sends data from one endpoint to another, performing any transformation of the data as required. When a stream is added, an underlying process on the router checks the validity of the stream, checking for conflicts and illogical configurations.



Notes on data stream operation:

- When any changes to the Data stream manager configuration are detected, all data streams are stopped and restarted as per the new configuration.
- Multiple Modbus clients cannot connect simultaneously to Modbus serial slaves connected to the router.

Every stream requires two endpoints, Endpoint A and Endpoint B. In all cases, the flow of data is from Endpoint A to Endpoint B.

To create a new stream:

1. Click the **+Add** button on the right side of the page.

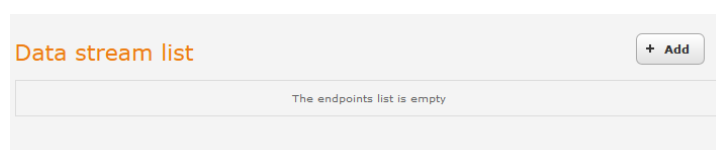

Figure 97 - Data stream list

The Edit data stream page is displayed.

- In the **Data stream name** field, enter a name for the Data stream.
- Under Endpoint A, use the **Endpoint name** drop down list to select one of the endpoints you created previously. This endpoint should be the starting point of the stream. Use the **Mode** drop down list to select the mode of operation of the endpoint. The mode can be thought of as a transformation of the data as it leaves this endpoint. For example, if Endpoint A type is Serial port (generic), the Mode can be set to various Modbus server and client types. This means that upon arrival at Endpoint A, the data will be transformed into the chosen Modbus format, ready to be sent to Endpoint B.
- Under Endpoint B, use the **Endpoint name** drop down list to select one of the endpoints you created previously. This endpoint should be the destination of the stream. The screenshot below shows a configuration sending data received on an attached serial port to a TCP server running on the router. Use the **Mode** drop down list to select the mode of operation of the endpoint. The mode can be thought of as a transformation of the data as it arrives at this endpoint.

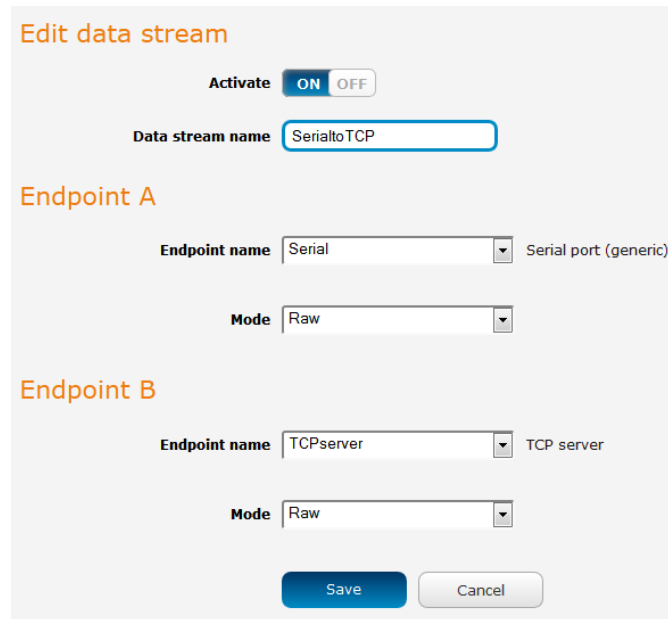
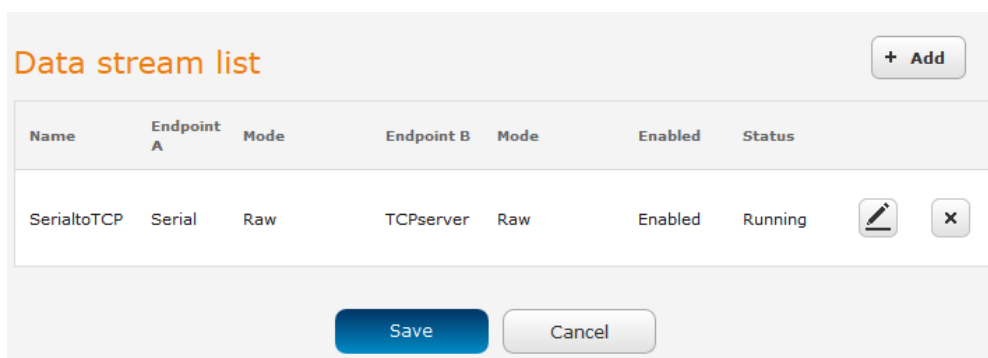

Figure 98 - Edit data stream

- Click the **Save** button. The new stream appears in the Data stream list.



Name	Endpoint A	Mode	Endpoint B	Mode	Enabled	Status
SerialtoTCP	Serial	Raw	TCPserver	Raw	Enabled	Running

Figure 99 - Data stream list

Data stream applications

ENDPOINT A	ENDPOINT B	ENDPOINT A MODE / ENDPOINT B MODE	ENDPOINTS CAN BE REVERSED	UNDERLYING PROCESS	APPLICATION
1 (Serial), 8 (RS232), 9 (RS485), 10 (RS422)	1 (Serial), 8 (RS232), 9 (RS485), 10 (RS422)	Raw/Raw	N/A	socat	Serial to serial raw data stream
1 (Serial), 8 (RS232), 9 (RS485), 10 (RS422)	2 (TCP Server), 3 (TCP Client), 4 (UDP Server), 5 (UDP Client)	Raw/Raw	Yes	socat	Serial to IP data stream
2 (TCP Server), 4 (UDP Server)	3 (TCP Client), 5 (UDP Client)	Raw/Raw	Yes	socat	Client to server data stream
1 (Serial), 8 (RS232), 9 (RS485), 10 (RS422)	3 (TCP Client)	Modbus Client Agent ASCII, Modbus Client Agent RTU/raw	No	dsm_data_mover	Modbus Client Agent functionality
1 (Serial), 8 (RS232), 9 (RS485), 10 (RS422)	2 (TCP Server)	Modbus Server Gateway ASCII, Modbus Server Gateway RTU/raw	No	dsm_data_mover	Modbus Server Gateway functionality
1 (Serial), 8 (RS232), 9 (RS485), 10 (RS422)	6 (GPS)	Raw/Raw	Yes	socat	Send GPS data to serial port
1 (Serial), 8 (RS232), 9 (RS485), 10 (RS422)	7 (User Executable)	Raw/Raw	Yes	socat	Send standard output of user-executable program to serial port
2 (TCP Server), 3 (TCP Client), 4 (UDP Server), 5 (UDP Client)	6 (GPS)	Raw/Raw	Yes	socat	Send GPS data to TCP or UDP client or server
2 (TCP Server), 3 (TCP Client), 4 (UDP Server), 5 (UDP Client)	7 (User Executable)	Raw/Raw	Yes	socat	Send standard output of user-executable program to TCP or UDP client or server
11 (Modem Emulator)	12 (PPP Server)	Raw/Raw	Yes	modem_emul_ep	Router terminated PPP Server functionality for dial-up PPP clients
11 (Modem Emulator)	13 (IP Modem)	Raw/Raw	Yes	modem_emul_ep	Modem emulation and tunneling via TCP/UDP (replacement for PAD Mode of the old Modem Emulator)
11 (Modem Emulator)	14 (CSD)	Raw/Raw	Yes	modem_emul_ep	Circuit Switched Data calls via 3G/4G module and mobile networks
1 (Serial), 8 (RS232), 9 (RS485), 10 (RS422)	15 (TCP Client Connect on Demand)	Raw/Raw	Yes	dsm_data_mover	Serial to TCP server connection, which is initiated ONLY when data is seen on serial port

Table 29 - Data stream applications

Legacy data managers

The Legacy data managers section provides the option to configure the built-in serial port to function with legacy equipment.



Note:

- Modem emulator and PAD Daemon may not be configured to use an external serial port such as one connected via USB.
- Because they may only use the built-in serial port, only one legacy data manager may be configured for use at any particular time. Additionally, when one of these legacy data managers is configured, any user-created data streams involving the built-in serial port endpoint will cause a conflict and result in all streams failing until the conflict is removed.
- The priority of the built-in serial port is (from highest to lowest): Data stream endpoints, PAD Daemon, Modem emulator

Modem emulator

Modem emulator allows you to connect legacy equipment such as an RTU or PLC to the serial port of the router in place of a traditional dial-up modem. The NTC-6200 series router emulates the dial-up modem's behaviour and passes the serial data over the IP network.



Note: Modem emulator is provided as a legacy data manager for existing installations. New installations should use Data stream manager as it includes all the functions of Modem emulator and provides more flexibility.

Modem emulator

Activate ON OFF

Serial port name /dev/ttyAPP4

Serial port status No conflicts

Modem Settings

Baud rate

Inter character timeout (0-65535) milliseconds

Id

Ignore string

Connection settings

Connect to

DTR action

DCD action

Flow control

RI action

Circuit auto answer rings

Auto dial number

Profile-specific settings

Profile

Remote Host

Port (1-65535)

Local encoding ON OFF

Mode

Auto answer ON OFF

Figure 100 - Modem emulator

ITEM	DESCRIPTION
Modem emulator	
Activate	Turns on or off the modem emulator function of the router.
Serial port name	The device name of the serial port.
Serial port status	The configuration status of the serial port. This will display whether there are any conflicts with the serial port preventing modem emulator from working properly.
Modem settings	
Baud rate	The serial (V.24) port baud rate. By default the serial line format is 8 data bits, No parity, 1 Stop bit. Refer to the AT (V.250) AT Command Manual if you need to change the serial line format.
Inter character timeout	The Modem emulator buffers any bytes received from the serial port until either 512 bytes have been received or no bytes have been received for "Inter Character Timeout" milliseconds, it will then send any bytes in the buffer to the remote host.
Id	When the ID field is not blank (empty) the defined ID will be sent to the remote host as follows: For UDP the 1st <n> bytes of each datagram sent will be set to the contents of the ID field, data follows immediately after the ID for TCP the ID is transmitted once immediately after the connection is established
Ignore string	When the "Ignore String" field is not blank (empty) the router will strip any character sequence that matches the "Ignore String" from the data stream received from the serial port.
Connection settings	
Connect to	Determines how the router behaves when it receives an "ATD" command on the serial port. <ul style="list-style-type: none"> • Profile - Connect using "Data Connection Profile" • Circuit - Establish a circuit switched data connection • Packet - Connect to cellular packet network in PPP pass through mode • DialString - Examine the dialed digits and connect to Profile, Circuit or Packet as appropriate
DTR action	Determines how the router responds to change of state of the serial port DTR line <ul style="list-style-type: none"> • Ignore - Take no action • Command - High to Low transition of DTR causes the router to enter command mode (does not end call). • Hangup - High to Low transition of DTR causes the router to end call and enter command mode. • High AutoDial - Low to High transition of DTR causes the router to dial the Auto Dial Number, High to Low transition of DTR causes the router to end call and enter command mode. • Low AutoDial - High to Low transition of DTR causes the router to dial the Auto Dial Number, Low to High transition of DTR causes the router to end call and enter command mode. • Low Pass To AT Port - When DTR is low pass all AT commands directly to internal cellular data engine.
Flow control	<ul style="list-style-type: none"> • Off - Serial port flow control off • Hardware - Serial port uses RTS/CTS flow control
RI action	Determines how the router controls the state of the serial port RI line <ul style="list-style-type: none"> • Always On - RI is always on • Incoming Ring - RI is on when an incoming connection request is received. • Always Off - RI is always off
Circuit auto answer rings	Sets the number of incoming rings after which the router will answer incoming circuit switched data calls.
Auto dial number	Sets the number the router will dial if DTR Auto Dial is enabled and DTR changes state.
Profile-specific settings (these items may be configured separately for each of the 4 connection profiles)	
Profile	Choose the profile that you want to configure.
Remote Host	In client mode (router connects to host) this is the remote host to which the router will connect. In server mode (remote host connects to router) the router will only accept incoming connections from the specified host. If you specify 0.0.0.0 the router will accept incoming connections from any host.
Port	TCP/UDP port number to use
Local encoding	Refer to the AT (V.250) Command Manual for details of this parameter, this is normally disabled.
Mode	Selects the mode of operation for the chosen profile. Mode may be TCP, UDP or GMP.
Auto answer	When enabled the router accepts incoming connections (enables server mode)

Table 30 - Modem emulator options

PADD

PAD Daemon is a tool used to encapsulate raw serial data into a TCP packet to be transported over IP to another end point. The server receiving the TCP packets unpacks the data and the original raw serial data is passed out of its serial port to the attached device, thereby creating an invisible IP network to the two serial devices.

The PAD Daemon runs as a background process which can be accessed via the web configuration interface. The PADD configuration page is located under “Services > Legacy data managers > PADD”. The PADD is used usually with multiple connections or when redundant connections are needed. The PADD has two modes: the PADD TCP/IP Server mode and PADD TCP/IP Client Mode. When PADD is enabled, both the PADD server mode and PADD client mode can be run at the same time.

The PADD configuration page is shown below.

PADD

Activate ON OFF

Serial port status No conflicts

Debug level (0-2)

Serial port settings

Host port

Baud rate

Data bits

Stop bits

Parity

Flow control

Inter character timeout (x100ms)

End-of-line character ASCII code

Start of line timestamps Off YYYYMMDDHHMMSS

TCP/IP Server

Listening port 1-65535

Incoming connection is Exclusive Shared

TCP/IP Client

Connect to First available All available

Remote Host 1 Server:Port

Remote Host 2 Server:Port

Remote Host 3 Server:Port

Remote Host 4 Server:Port

Network

Remote server retry period 1-65535 seconds

TCP Keepalive Probes 0-65535 seconds (0=disabled)

Number of probe failures before disconnect 1 - 20

Figure 101 – PADD

Remote management

SNMP

SNMP configuration

The SNMP page is used to configure the SNMP features of the router.

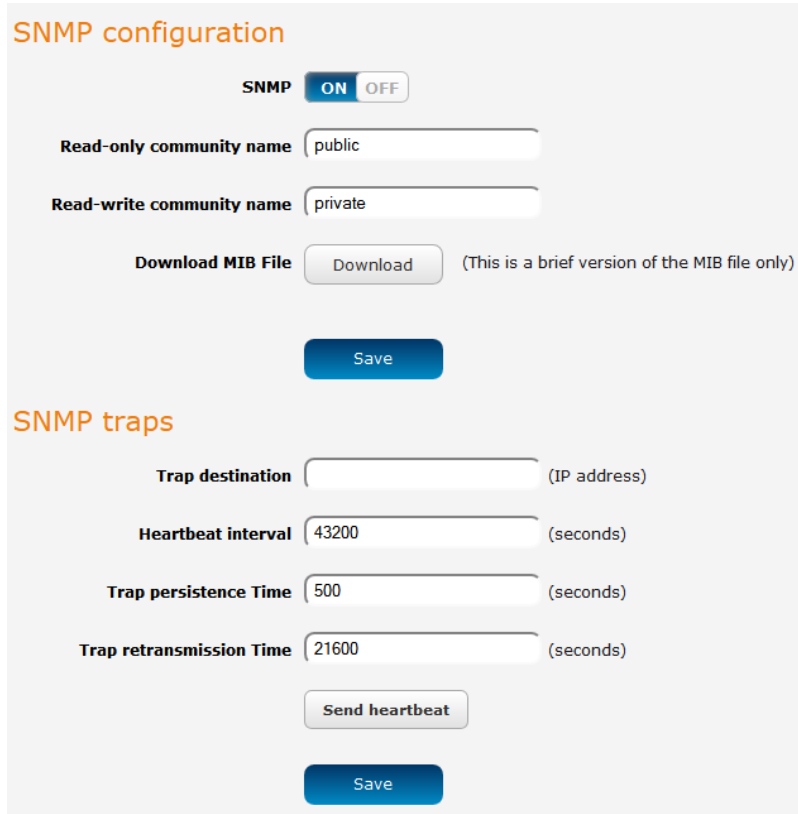

Figure 102 - SNMP configuration

SNMP (Simple Network Management Protocol) is used to remotely monitor the router for conditions that may warrant administrative attention. It can be used to retrieve information from the router such as the signal strength, the system time and the interface status.

To configure SNMP:

1. Click the **SNMP** toggle key to switch it to the **ON** position.
2. Enter **Read-only community name** and **Read-write community name** which are used for client authentication.



Community names are used as a type of security to prevent access to reading and/or writing to the routers configuration. It is recommended that you change the Community names to something other than the default settings when using this feature.

3. Click the **Save** button to save any changes to the settings.

The **Download** button displays the Management Information Base (MIB) of the router. The MIB displays all the objects of the router that can have their values set or report their status. The MIB is formatted in the SNMP-related standard RFC1155.

SNMP traps

SNMP traps are messages from the router to the Network Management System sent as UDP packets. They are often used to notify the management system of any significant events such as whether the link is up or down.

Configuring SNMP traps

To configure SNMP traps:

1. In the **Trap destination** field, enter the IP address to which SNMP data is to be sent.
2. In the **Heartbeat interval** field, enter the number of seconds between SNMP heartbeats.
3. Use the **Trap persistence** field to specify the time in seconds that an SNMP trap persists.
4. Use the **Trap retransmission** time to specify the length of time in seconds between SNMP trap retransmissions.

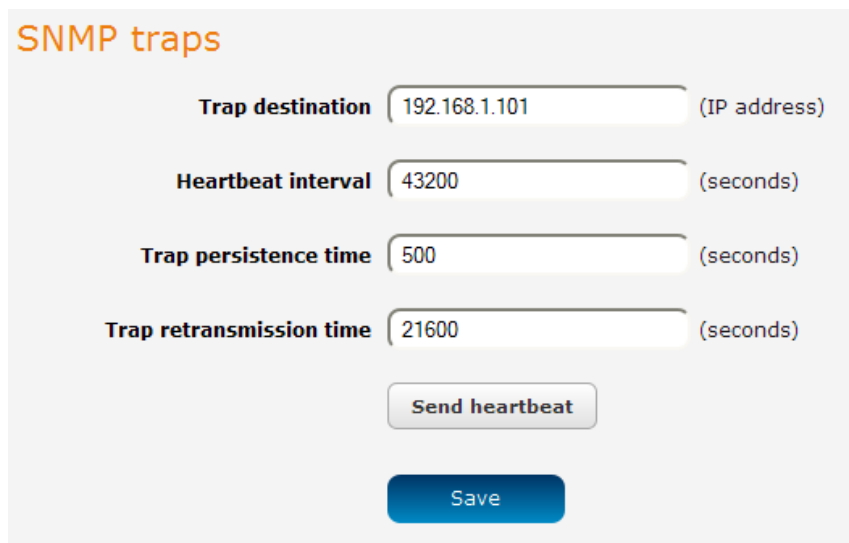

SNMP traps

Trap destination (IP address)

Heartbeat interval (seconds)

Trap persistence time (seconds)

Trap retransmission time (seconds)

Figure 103 - SNMP traps

To send a manual SNMP Heartbeat, click the **Send heartbeat** button. When you have finished configuring the SNMP traps, click the **Save** button to save the settings.



Note: When a factory reset is performed via SNMP, the SNMP settings are preserved.

TR-069

To access the TR-069 configuration page, click the **Services** menu item, then select the TR-069 menu item on the left.

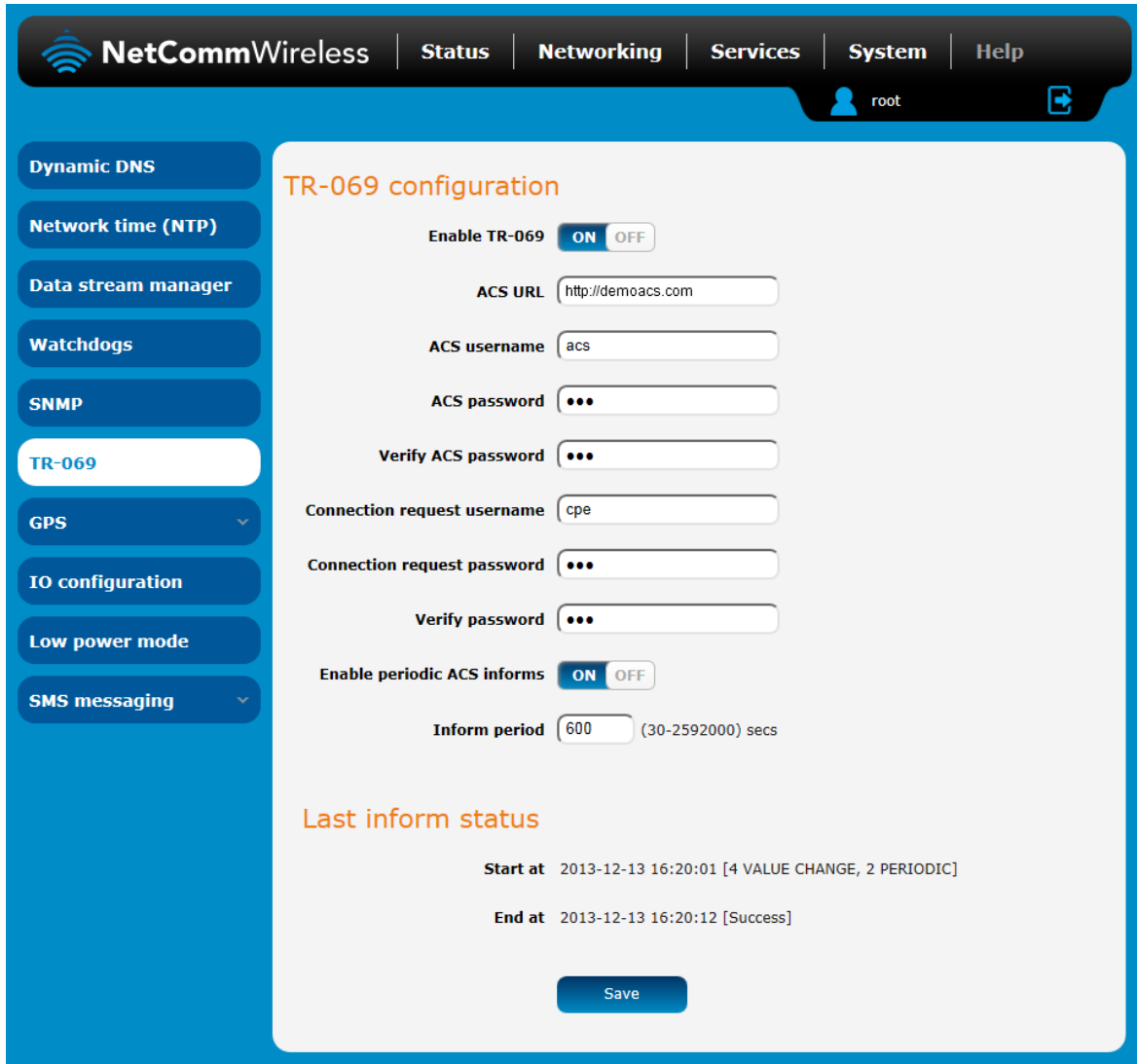





Figure 104 - TR-069 configuration

The TR-069 (Technical Report 069) protocol is a technical specification also known as CPE WAN Management Protocol (CWMP). It is a framework for remote management and auto-configuration of end-user devices such as customer-premises equipment (CPE) and Auto Configuration Servers (ACS). It is particularly efficient in applying configuration updates across networks to multiple CPEs.

TR-069 uses a bi-directional SOAP/HTTP-based protocol based on the application layer protocol and provides several benefits for the maintenance of a field of CPEs:

-  Simplifies the initial configuration of a device during installation
-  Enables easy restoration of service after a factory reset or replacement of a faulty device
-  Firmware and software version management
-  Diagnostics and monitoring



Note: You must have your own compatible ACS infrastructure to use TR-069. In order to access and configure the TR-069 settings you must be logged into the router as the root user.



Note: When a factory reset of the router is performed via TR-069, the TR-069 settings are preserved.

TR-069 configuration

To configure TR-069:

1. Click the **Enable TR-069** toggle key to switch it to the **ON** position.
2. In the **ACS URL** field, enter the Auto Configuration Server's full domain name or IP address.
3. Use the **ACS username** field to specify the username for the Auto Configuration Server.
4. In the **ACS password** and **Verify ACS password** fields, enter the Auto Configuration Server password.
5. In the **Connection Request Username** field, enter the username to use for the connection requests.
6. In the **Connection Request Password** and **Verify password** fields, enter the connection request password.
7. The inform message acts as a beacon to inform the ACS of the existence of the router. Click the **Enable periodic ACS informs** toggle key to turn on the periodic ACS inform messages.
8. In the **Inform Period** field, enter the number of seconds between the inform messages.
9. Click the **Save** button to save the settings.



OMA Lightweight M2M configuration



Note: The OMA Lightweight M2M specification has not yet been finalised. As such, the current implementation of OMA-LWM2M is experimental and should not be deployed for regular use. We also do not recommend using OMA-LWM2M while the router is connected to an APN providing a publicly routable IP address.

The OMA Lightweight M2M (OMA-LWM2M) protocol was designed by the Open Mobile Alliance to provide remote device management specifically for M2M devices. It is less taxing on the system and network than OMA-DM and TRS-069. OMA-LWM2M runs over UDP and supports asynchronous notifications when a resource changes.

It provides:

-  Firmware upgrades
-  Device monitoring and configuration
-  Server provisioning

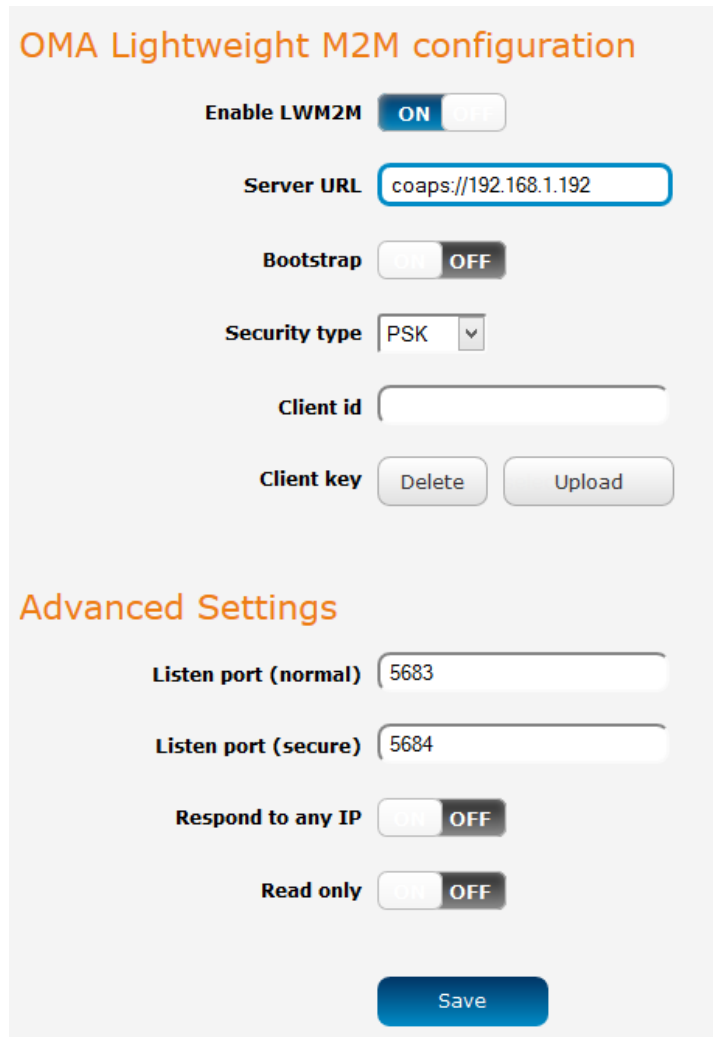

The screenshot shows a web configuration page titled "OMA Lightweight M2M configuration". It features several settings:

- Enable LWM2M:** A toggle switch currently set to "ON".
- Server URL:** A text input field containing "coaps://192.168.1.192".
- Bootstrap:** A toggle switch currently set to "OFF".
- Security type:** A dropdown menu currently set to "PSK".
- Client id:** An empty text input field.
- Client key:** Two buttons labeled "Delete" and "Upload".

Below these settings is a section titled "Advanced Settings" with the following options:

- Listen port (normal):** A text input field containing "5683".
- Listen port (secure):** A text input field containing "5684".
- Respond to any IP:** A toggle switch currently set to "OFF".
- Read only:** A toggle switch currently set to "OFF".

A large blue "Save" button is located at the bottom of the configuration area.

Figure 105 - OMA Lightweight M2M configuration

ITEM	DESCRIPTION
Enable LWM2M	Toggles the OMA-LWM2M function on and off.
Server URL	The URL of the LWM2M server. This must begin with coap:// or coaps:// and include the server port number. The correct syntax for this field is <code>coap://<server IP or domain name>:<port number></code> . The Server URL field performs validation on the entered address so the field must contain an address in the correct format.
Listen port (normal)	The port that the router listens on for LWM2M.
Listen port (secure)	When using DTLS (coaps), enter the port that the router listens on for secure connections.
Security type (only used when Server URL starts with coaps://)	NoSec – When selected, this uses DTLS with the NULL cipher, therefore, it provides no security.
	PSK – Pre-shared key mode. Keys are typically a string of text saved into a text file. We recommend creating a key at least 32 bytes in size to enhance your security.
	RPK – Raw Public Key. The key is an EC key in DER format. It must contain both public and private keys. When RPK is selected, the Client ID field is not used. You can generate a raw public key using commands such as: <code>openssl ecparam -out 256.key -name secp256r1 -genkey</code> <code>openssl ec -in 256.key -outform der -out 256.der</code>
Client id (only used when Server URL starts with coaps:// and Security type is PSK)	When server is a coaps:// address and security type is set to PSK, the Client id acts as a means of identifying the client, similar to a username.
Client key (only used when Server URL starts with coaps:// and Security type is PSK or RPK)	This field is used to upload the key file used when security type is set to PSK, delete the uploaded key file or show the currently stored key.
Respond to any IP	When turned on, this feature adds a firewall rule that allows the router to respond to any IP address on the designated port. This eases the restrictions that requests must come from servers the client is currently registered with. We recommend that this feature is turned off for normal use.
Bootstrap	When set to the ON position, this specifies that the Server URL field points to a bootstrap server.
Read only	When set to the ON position, this allows read only access to all LWM2M settings. Writing new values and executing commands are not permitted. When set to OFF, values may be read, written and executed.

Table 31 – OMA Lightweight M2M configuration options

Supported objects

The objects and instances used by NetComm Wireless routers are all part of the Open Mobile Alliance and IPSO Alliance approved list. At this time, there are no NetComm-specific objects or instances. For more information on the Lightweight M2M specifications, please visit the Open Mobile Alliance Specifications for Public Comment website:

<http://technical.openmobilealliance.org/Technical/technical-information/specifications-for-public-comment>

Timeouts

Most mobile networks use stateful firewalls or NAT where the timeout for UDP is approximately 1-2 minutes. If this applies to you, configure your server to change the 'lifetime' (resource 1/0/1) to be shorter than the default 86400. We suggest setting it to 60.

Supported ciphers





- 🌀 TLS_PSK_WITH_AES_128_CBC_SHA256
- 🌀 TLS_ECDHE_ECDSA_WITH_AES_128_CBC_SHA256
- 🌀 NULL (only if "NoSec" explicitly selected)
- 🌀 Others may be negotiated by OpenSSL during connection

GPS

On models with a built-in GPS, you are able to use location-based services, monitor field deployed hardware or find your current location. The GPS Status window provides up to date information about the current location and the current GPS signal conditions (position dilution of precision (PDOP), horizontal dilution of precision (HDOP) and vertical dilution of precision (VDOP)) of the router.

NMEA support

The router supports the National Marine Electronics Association NMEA-0183 compatible (V2.3) standard of sending GPS data. The standard includes “sentences” used to identify the type of data being sent and therefore defines the way the data is interpreted. The supported GPS related sentences are listed below:

-  GPGGA – Global Positioning System Fix Data, Time, Position and fix related data for a GNSS receiver
-  GPRMC – Recommended minimum data for GPS
-  GPGSV – Detailed satellite data
-  GPGSA – Overall satellite data
-  GPVTG – Vector track and speed over the Ground

GPS configuration

To access the GPS configuration screen, select the **Services** item from the top menu bar then the **GPS** item on the left. Finally, select the **GPS configuration** menu item.

To use the GPS function, set the **GPS operation** toggle key to **ON** and click the **Save** button.

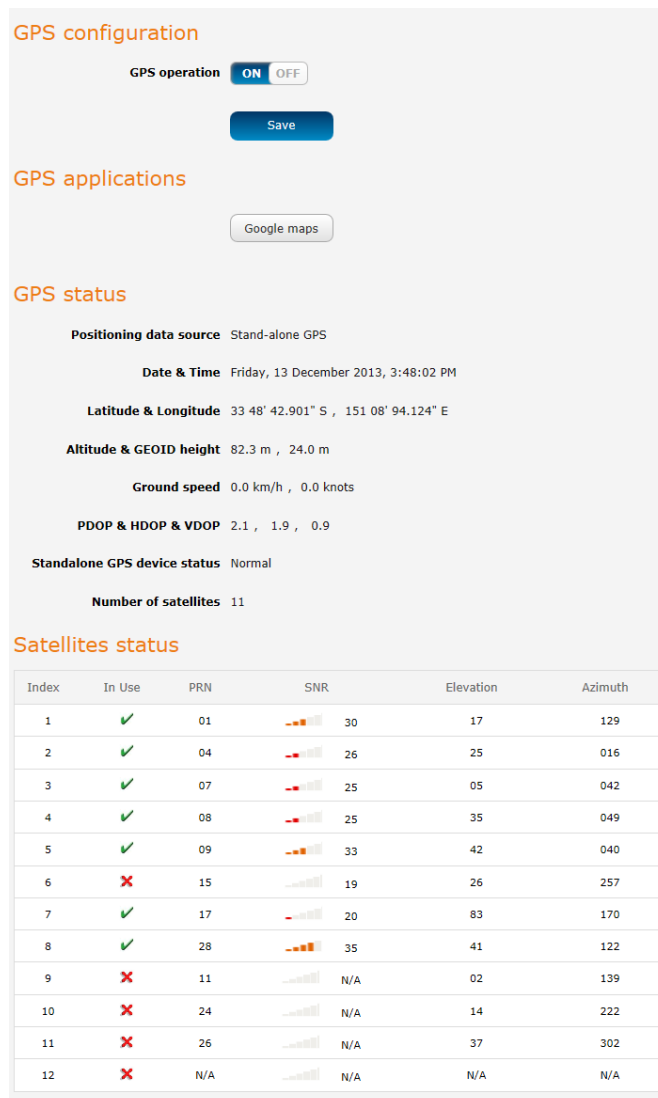

GPS configuration

GPS operation **ON** OFF

Save

GPS applications

Google maps

GPS status

Positioning data source Stand-alone GPS

Date & Time Friday, 13 December 2013, 3:48:02 PM

Latitude & Longitude 33 48' 42.901" S , 151 08' 94.124" E

Altitude & GEOID height 82.3 m , 24.0 m

Ground speed 0.0 km/h , 0.0 knots

PDOP & HDOP & VDOP 2.1 , 1.9 , 0.9

Standalone GPS device status Normal

Number of satellites 11

Satellites status

Index	In Use	PRN	SNR	Elevation	Azimuth
1	✓	01	30	17	129
2	✓	04	26	25	016
3	✓	07	25	05	042
4	✓	08	25	35	049
5	✓	09	33	42	040
6	✗	15	19	26	257
7	✓	17	20	83	170
8	✓	28	35	41	122
9	✗	11	N/A	02	139
10	✗	24	N/A	14	222
11	✗	26	N/A	37	302
12	✗	N/A	N/A	N/A	N/A

Figure 106 – GPS configuration

The **Google maps** button provides a quick short cut to show your router's current position on a map.

Mobile Station Based Assisted GPS configuration

To access the Mobile Station Based Assisted GPS configuration screen, select the **Services** item from the top menu bar then the **GPS** item on the left. Finally, select the **MSB (A-GPS)** menu item. This function is only available on models with built-in GPS capability.

Mobile Station Based Assisted GPS (MSB A-GPS) enables your router to download GNSS data which supply orbital data to GPS receiver, enabling it to lock to the satellites more rapidly greatly reduces the time required for the GPS to accurately locate the router's position. The GNSS data is stored on the router to assist the GPS in locating the router.

To set up automatic updates of GNSS data, set the **A-GPS Enable** toggle key to the **ON** position and use the drop down lists to configure the automatic retry options. Each retry, the router checks for an updated GNSS data file and downloads the GNSS data if newer than the currently stored data.



Note: When new GNSS data is available and the router performs an update, up to 40MB of data may be downloaded. Please keep this in mind if your mobile broadband plan has usage restrictions.

Mobile Station Based Assisted GPS configuration

A-GPS Enable ON OFF

Maximum Retry Count

Retry Delay (minute)

Automatic Update Period (day)

GNSS data last update Saturday, 7 December 2013 9:00:00 AM

GNSS data expires Thursday, 19 December 2013 9:00:11 AM

A-GPS last update Thursday, 12 December 2013 9:36:28 AM

Figure 107 - Mobile Stations Based Assisted GPS configuration options

ITEM	DESCRIPTION
A-GPS Enable	Enables or disables the mobile station based assisted GPS function.
Maximum Retry Count	Sets the maximum number of times the router should attempt to triangulate its position.
Retry delay (minute)	Sets the number of minutes the router should wait between attempts to triangulate its position.
Automatic Update Period (day)	Sets the number of days that the router should automatically update the A-GPS data. The maximum update period is 7 days.

Table 32 - Mobile Station Based Assisted GPS configuration options

The **GNSS data last update** field represents the time that the GNSS data file was created while the **GNSS data expires** field indicates the time that this data is valid until. The **A-GPS last update** field specifies the last time the router attempted to retrieve an update to the GNSS data.

You may manually force the router to check for an update regardless of the next scheduled update time by clicking the **Update Now** button.

When you have finished configuring the settings, click the **Save** button to save the changes.

Odometer

To access the Odometer screen, select the **Services** item from the top menu bar then the **GPS** item on the left. Finally, select the **Odometer** menu item.

The GPS may be used to record the distance that the router has travelled. To do this, set the **Odometer** toggle key to the **ON** position as in the screenshot below. You can toggle the unit of measurement by clicking the **Display imperial / Display metric** button. The threshold setting adjusts the router's sensitivity to movement so that movement within the specified radius from the starting point does not register as distance travelled. When you have finished configuring the Odometer settings, click the **Save** button to ensure the settings are stored on the router.

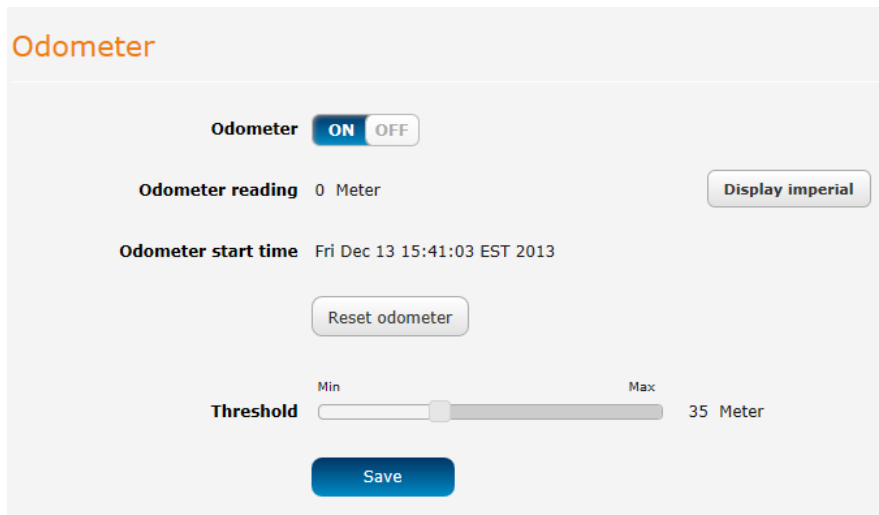







Figure 108 – Odometer options

ITEM	DESCRIPTION
Odometer reading	The number of metres/kilometres that the device has travelled since the time listed in the Odometer start time field.
Display imperial / Display metric	Toggles the Odometer reading between metric and imperial measurements.
Odometer start time	The time that recording of distance travelled began.
Reset odometer	Resets the odometer reading to 0 and the Odometer start time to the current time.
Odometer	Toggles the Odometer function on and off.
Threshold	Specifies the minimum distance that the router must travel from its current position before the Odometer reading increases.

Table 33 - Odometer configuration options

IO configuration

The NTC-6200 Series Router is equipped with a 6-way terminal block connector providing 3 identical multipurpose inputs and outputs as well as a dedicated ignition input. These inputs and outputs may be independently configured for various functions, including:

-  NAMUR (EN 60947-5-6 / IEC 60947-5-6) compatible proximity sensor input
-  Proximity sensor input for use with contact closure (open/closed) type of sensors (PIR sensors, door/window sensors for security applications) with the input tamper detection possible (four states detected: open, closed, short and break) by the use of external resistors
-  Analogue 0V to 30V input
-  Digital input (the I/O voltage measured by the Analogue input and the software making decision about the input state) with the threshold levels configurable in software
-  Open collector output.

Use the pull up voltage options to select the desired output voltage of the I/O pins. The pull up voltage you select will be the same for each pin when pull up is enabled for that pin. Each pin is capable of outputting either 3.3V or 8.2V.

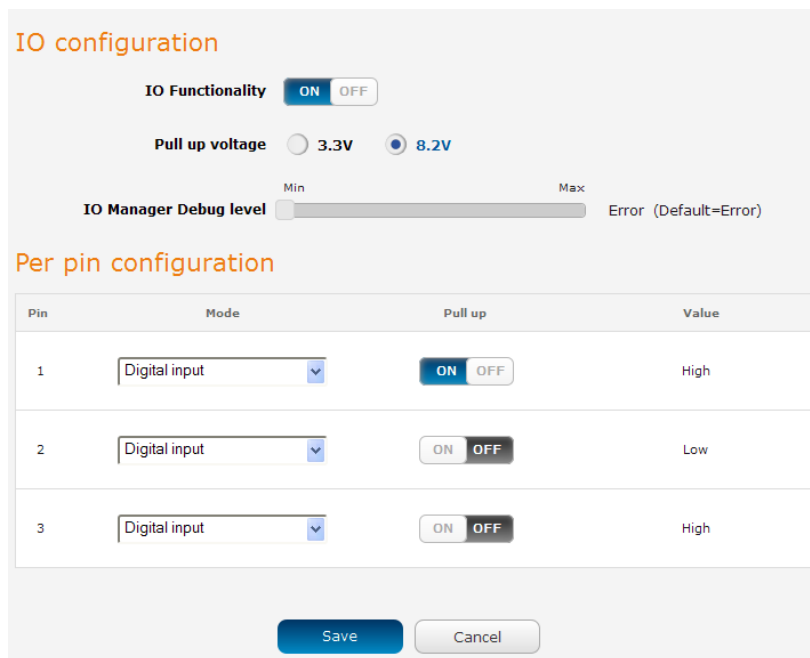

Figure 109 – IO configuration options

ITEM	DESCRIPTION
IO configuration	
IO Functionality	Enables the configuration of the input and output pins on the Six-way terminal block.
Pull up voltage	Specifies the output voltage of the I/O pins.
IO Manager Debug level	Use the slide bar to adjust the level of detail you would like to see in the log for IO messages. A higher debug level displays more detailed messages in the log file.
Per pin configuration	
Pin	The I/O pin number corresponding to the pin on the terminal block that you wish to configure.
Mode	The mode of operation for the corresponding pin. Available options are Digital input, Digital output, Analogue input, Namur input, Contact closure input.
Pull up	Use the pull up toggle keys to turn the pull up on or off for the corresponding pin. When turned on, the pull up voltage output is the value specified in the "Pull up voltage" option.
Value	The value column displays whether the voltage detected on the line is low or high or allows you to configure the output value in the case that the pin is set to digital output. This can be useful for applications where monitoring of the transition between low and high is used to trigger an action.

Table 34 - IO configuration options

The table below describes the different modes available on the physical I/O pins of the router.

MODE	DESCRIPTION
Digital input	The corresponding pin accepts digital input. Pull up may be on or off and both 3.3V and 8.2V are available as pull up voltages. The value column displays whether the signal received on the pin is High or Low.
Digital output	The corresponding pin outputs a digital signal. Pull up may be on or off and both 3.3V and 8.2V are available as pull up voltages. The value column contains a toggle key allowing you to set whether the output signal is High or Low.
Analogue input	The corresponding pin accepts an analogue signal. Pull up may be on or off and both 3.3V and 8.2V are available as pull up voltages. The value column displays the current voltage detected on the pin.
Namur input	NAMUR is a sensor standard using low-level current signals. It can supply two different signal levels depending on the state of the switch and is commonly used in hazardous or explosive locations where compact sensors are required. When a pin is set to NAMUR mode, Pull up is turned on and the global Pull up voltage is set to 8.2V. These settings may not be changed for as long as a pin is set to NAMUR mode as they are required settings according to the NAMUR IEC 60947 -5-6 standard. The value column displays whether the signal received on the pin is High or Low.
Contact closure input	A common type of digital input where a sensor or switch opens or closes a set of contacts as a result of a process change. An electrical signal is then used to determine whether the circuit is open or closed. When a pin is set to Contact closure input, Pull up is enabled for that pin and may not be turned off as long as the pin remains configured as a Contact closure input. Global pull up voltage may be either 3.3V or 8.2V.

Table 35 - IO pin modes



Note: Please refer to the SDK Developer Guide for hardware information about the Input/Output pins, wiring examples and configuration of the pins via the command line interface. There are also wiring examples in Appendix G of this User Guide. Contact NetComm Wireless Technical Support for access to the Software Development Kit.

Event notification

The event notification feature is an advanced remote monitoring tool providing you with the ability to send alerts via SMS, e-mail, TCP or UDP when pre-defined system events occur.

Notification configuration

The Notification configuration screen is used to select the event types, methods of notification and the destinations for the notifications. Up to four types of alerts for a particular event may be sent to a single destination profile containing the contact details.

Event notification configuration

Enable event notification ON OFF

Maximum event buffer size (100-10000)

Maximum retry count (1-20)

Event notification log file

Unit ID

Event description	Event number	Email	TCP	UDP	SMS	Destination profile	Filter
Unit powered up	1	<input type="checkbox"/>	<input type="checkbox"/>	<input type="checkbox"/>	<input type="checkbox"/>	Default <input type="text"/>	
Unit rebooted	2	<input type="checkbox"/>	<input type="checkbox"/>	<input type="checkbox"/>	<input type="checkbox"/>	Default <input type="text"/>	
Link status change	3	<input type="checkbox"/>	<input type="checkbox"/>	<input type="checkbox"/>	<input type="checkbox"/>	Default <input type="text"/>	
WWAN IP address change	4	<input type="checkbox"/>	<input type="checkbox"/>	<input type="checkbox"/>	<input type="checkbox"/>	Default <input type="text"/>	
WWAN Registration change	5	<input type="checkbox"/>	<input type="checkbox"/>	<input type="checkbox"/>	<input type="checkbox"/>	Default <input type="text"/>	
WWAN Cell ID change	6	<input type="checkbox"/>	<input type="checkbox"/>	<input type="checkbox"/>	<input type="checkbox"/>	Default <input type="text"/>	
WWAN technology change	7	<input type="checkbox"/>	<input type="checkbox"/>	<input type="checkbox"/>	<input type="checkbox"/>	Default <input type="text"/>	
Number of connected Ethernet interfaces change	8	<input type="checkbox"/>	<input type="checkbox"/>	<input type="checkbox"/>	<input type="checkbox"/>	Default <input type="text"/>	
Web UI login failure	10	<input type="checkbox"/>	<input type="checkbox"/>	<input type="checkbox"/>	<input type="checkbox"/>	Default <input type="text"/>	
Digital input change	15	<input type="checkbox"/>	<input type="checkbox"/>	<input type="checkbox"/>	<input type="checkbox"/>	Default <input type="text"/>	<input type="button" value="configure"/>
Analog input threshold	16	<input type="checkbox"/>	<input type="checkbox"/>	<input type="checkbox"/>	<input type="checkbox"/>	Default <input type="text"/>	<input type="button" value="configure"/>
Digital output change	17	<input type="checkbox"/>	<input type="checkbox"/>	<input type="checkbox"/>	<input type="checkbox"/>	Default <input type="text"/>	<input type="button" value="configure"/>

Figure 110 - Event notification configuration

ITEM	DESCRIPTION
Enable event notification	Toggles the event notification feature on and off.
Maximum event buffer size	Specifies the buffer size for event notifications which failed to be delivered or are yet to be sent. The minimum size is 100 and the maximum is 10000.
Maximum retry count	Specifies the maximum number of attempts that the router will make to deliver an event notification. The range is between 1 and 20.
Event notification log file	Specifies to the location and name of the file used to log the event notification activity.
Event notification prefix	The Unit ID field is used to specify an identifier for the router which are sent in the event notifications so that you know which router has an event.

Table 36 - Event notification configuration options

Event types

There are ten events for which you can configure alerts. Hovering the mouse over the event description provides more details of event notification type.

NUMBER	EVENT	DESCRIPTION	EXAMPLE MESSAGE
1	Unit powered up	Notification is sent when the unit is powered up through connection of a power source or after a soft-reset.	Power is up
2	Unit rebooted	Notification is sent when the unit is rebooted via Web UI, SMS diagnostics or via command line/telnet session.	Rebooting triggered by internal application
3	Link status change	Notification is sent if the status of the data connection profile or any IPSec/OpenVPN/PPTP/GRE tunnel endpoint changes i.e. the link goes up or down.	Profile 1 WWAN status changed : down --> up
4	WWAN IP address change	Notification is sent if an active data connection profile's WWAN IP address changes.	WWAN IP address changed : N/A --> 10.103.4.149
5	WWAN Registration change	Notification is sent if the network registration status changed between "registered", "unregistered" or "roaming".	WWAN registration status changed : Not registered --> Registered to home network
6	WWAN Cell ID change	Notification is sent if the router connects to a different cell, marked by a changed in the Cell ID.	Cell ID changed : --> 15224145 Cell ID changed : 15224148 -> 15224145
7	WWAN technology change	Notification is sent if the router connects to a different network technology, e.g. 3G/2G.	WWAN network changed : N/A --> 3G(UMTS) WWAN network changed : 3G(UMTS) --> 2G(GSM)
8	Number of connected Ethernet interfaces change	Notification is sent if there is a change to the number of directly connected Ethernet interfaces.	Ethernet device number changed : 0 --> 1
10	Web UI login failure	Notification is sent if there was a failure to log in to the router via the Web UI.	Failover instance occurred: N/A --> wwan.0 Failover instance occurred: eth.0 --> wwan.0
15	Digital input change	Notification is sent if an IO pin configured as a digital input goes high or low for a specified period.	IO pin 1 now high IO pin 2 now low
16	Analog input threshold	Notification is sent if an IO pin configured as an analog input reaches a specified high or low voltage for a specified period.	IO pin 1 now high IO pin 2 now low
17	Digital output change	Notification is sent if an IO pin configured as a digital output goes high or low for a specified period.	IO pin 1 now high IO pin 2 now low

Table 37 - Event notification – event types

IO event configuration

IO events have an additional configuration screen which can be accessed by clicking on the **Configure** button for the chosen event type. Note that pins which do not have a configuration that matches the event type have their options greyed out, for example, a pin configured as an analogue input or digital output may not be configured to notify on digital input change. Check the configuration of the IO pins before configuring the event notification for IO events.

Each IO event can be configured to notify both when a high and a low value is reached for a specified period of time provided in milliseconds. The analog input IO event also allows you to specify the high and low voltage thresholds that must be reached for the specified period before a notification is sent.



Note: Take care when setting the IO event notification values since certain configurations may result in a large number of notifications being sent and this can cause additional data to be consumed or SMS messages to be sent which can lead to additional charges on your wireless broadband account.

Digital input change

Event notification configuration

Filter: Digital input change

Pin types are configured in IO Configuration

Option	Pin 1	Pin 2	Pin 3
Notify when high	<input type="checkbox"/>	<input type="checkbox"/>	<input type="checkbox"/>
Notify when low	<input type="checkbox"/>	<input type="checkbox"/>	<input type="checkbox"/>
Must be high for (ms)	<input type="text" value="500"/>	<input type="text" value="500"/>	<input type="text" value="500"/>
Must be low for (ms)	<input type="text" value="500"/>	<input type="text" value="500"/>	<input type="text" value="500"/>

Figure 111 – Digital input change event notification configuration

Analog input threshold

Event notification configuration

Filter: Analog input threshold

Pin types are configured in IO Configuration

Option	Pin 1	Pin 2	Pin 3
Notify when high	<input type="checkbox"/>	<input type="checkbox"/>	<input type="checkbox"/>
Notify when low	<input type="checkbox"/>	<input type="checkbox"/>	<input type="checkbox"/>
Must be high for (ms)	<input type="text" value="500"/>	<input type="text" value="500"/>	<input type="text" value="500"/>
Must be low for (ms)	<input type="text" value="500"/>	<input type="text" value="500"/>	<input type="text" value="500"/>
High threshold (V)	<input type="text" value="0"/>	<input type="text" value="0"/>	<input type="text" value="0"/>
Low threshold (V)	<input type="text" value="0"/>	<input type="text" value="0"/>	<input type="text" value="0"/>

Figure 112 – Analog input threshold event notification configuration

Digital output change

Event notification configuration

Filter: Digital output change

Pin types are configured in IO Configuration

Option	Pin 1	Pin 2	Pin 3
Notify when high	<input type="checkbox"/>	<input type="checkbox"/>	<input type="checkbox"/>
Notify when low	<input type="checkbox"/>	<input type="checkbox"/>	<input type="checkbox"/>
Must be high for (ms)	<input type="text" value="500"/>	<input type="text" value="500"/>	<input type="text" value="500"/>
Must be low for (ms)	<input type="text" value="500"/>	<input type="text" value="500"/>	<input type="text" value="500"/>

Figure 113 – Digital output change event notification configuration

Destinations

A “destination” is a profile on the router containing the contact details of a recipient of event notification alerts i.e. the e-mail address, SMS number, TCP or UDP server addresses of the recipient. The destination profile must contain the details of at least one destination type in order to be used.

Configuring Event notification

To configure the event notification feature:

1. Click the Services menu item at the top of the screen. From the Event notification menu on the left of the screen, select the **Destination configuration** menu item.
2. Click the **+Add** button at the top right corner of the window. The Event destination edit screen is displayed.
3. In the **Destination name** field enter a name for the destination profile then enter the contact details for the each type of destination i.e. Email address, TCP address and port, UDP address and port and/or SMS number.
4. Click the **Save** button when you have entered the required details.
5. From the Event notification menu on the left of the screen, select the **Notification configuration** menu item.
6. Select the **Enable event notification** toggle key to turn it to the **ON** position.
7. If desired, set the **Maximum event buffer size**, **Maximum retry count**, **Event notification log file** and **Event notification prefix** fields. See table 23 for descriptions of these options.
8. From the **Destination** column, use the drop down menus to select the desired destination profiles to use for the corresponding events, then select the checkboxes for the types of notifications to send to the chosen destination profile. If the Destination profile does not contain the required contact details, a pop-up warns you to enter the required details in the Destination profile.
9. Click the **Save** button.



Note: If you have selected the Email notification type for any of the events, you must also configure Email client settings to allow the router to send e-mail messages.

Destination configuration

The Destination configuration screen displays a list of the destination “profiles” that have been configured on the device as well as providing the option to add new profiles.

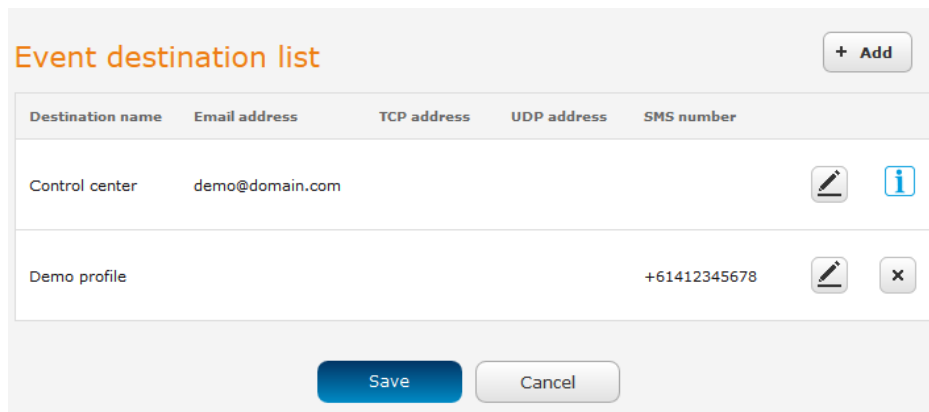

Figure 114 - Event destination list

To add a new destination profile:

1. Click the **+Add** button at the top right corner of the window. The Event destination edit screen is displayed.
2. In the **Destination name** field enter a name for the destination profile then enter the contact details for the each type of destination i.e. Email address, TCP address and port, UDP address and port and/or SMS number.
3. Click the **Save** button when you have entered the required details.

To edit a destination profile:

1. From the Event destination list, click the edit button for the corresponding destination profile. The Event destination edit page is displayed. Make the required changes.
2. Click the **Save** button.

To delete a destination profile:

1. From the Event destination list, select the delete button for the corresponding destination profile that you would like to delete. If the destination profile is linked to an event notification type, the **i** button is displayed instead of the delete button. In this case, you must go to the **Notification configuration** screen and remove the check marks from all the notification types for each event for which the destination profile is configured. When you have done that, return to the Event destination list and select the delete button.
2. Click the **Save** button.

Email settings

The Email settings screen allows the configuration of the email account that is used to send emails in features such as Event notification.

To access the Email settings page, click the **Services** menu item then select the **Email settings** menu item on the left.

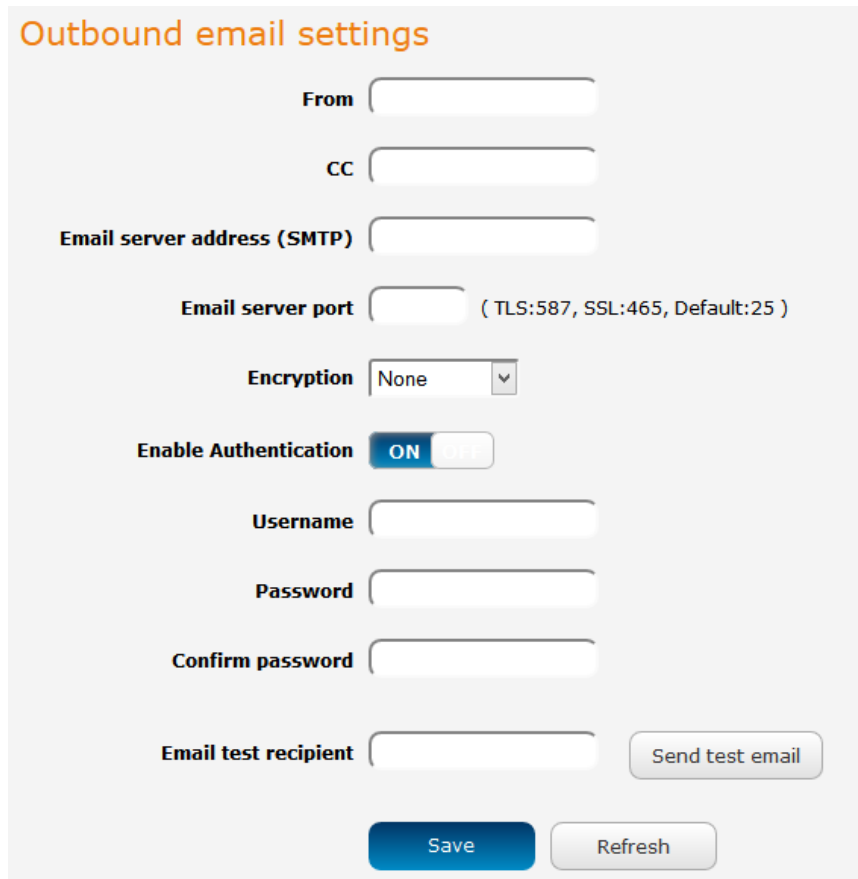

Figure 115 - Email client settings









ITEM	DESCRIPTION
From	Enter the email address of the account you will be using to send emails.
CC	(Optional) Enter an email address which will be copied on all messages sent.
Email server address (SMTP)	Enter the SMTP server address of the email server. This may be an IP address or a hostname.
Email server port	Enter the Email server's SMTP port.
Encryption	Use this drop down list to select the type of encryption to apply to the mail server connection.
Enable Authentication	If your mail server requires account authentication before it allows mail to be sent, enable this option and enter the account details in the Username and Password fields below.
Username	Enter the username of the account to be used for sending emails.
Password	Enter the password of the account to be used for sending emails.
Confirm password	Enter the password of the account to be used for sending emails once more for confirmation.
Email test recipient	Enter an email address to send a test message to, then click the Send test email button.

Table 38 - Email client settings

SMS messaging

The NTC-6200 Series router offers an advanced SMS feature set, including sending messages, receiving messages, redirecting incoming messages to another destination, as well as supporting remote commands and diagnostics messages.

Some of the functions supported include:

-  Ability to send a text message via a 2G/3G network and store it in permanent storage.
-  Ability to receive a text message via a 2G/3G network and store it in permanent storage.
-  Ability to forward incoming text messages via a 2G/3G network to another remote destination which may be a TCP/UDP server or other mobile devices.
-  Ability to receive run-time variables from the device (e.g. uptime) on request via SMS
-  Ability to change live configuration on the device (e.g. network username) via SMS.
-  Ability to execute supported commands (e.g. reboot) via SMS
-  Ability to trigger the NTC-6200 Series router to download and install a firmware upgrade
-  Ability to trigger the NTC-6200 Series router to download and apply a configuration file

To access the SMS messaging functions of the NTC-6200 Series router, click on the **Services** menu item from the top menu bar, and then select one of the options under the **SMS messaging** section on the left hand menu.

Setup

The Setup page provides the options to enable or disable the SMS messaging functionality and SMS forwarding functionalities of the router. SMS messaging is enabled by default.

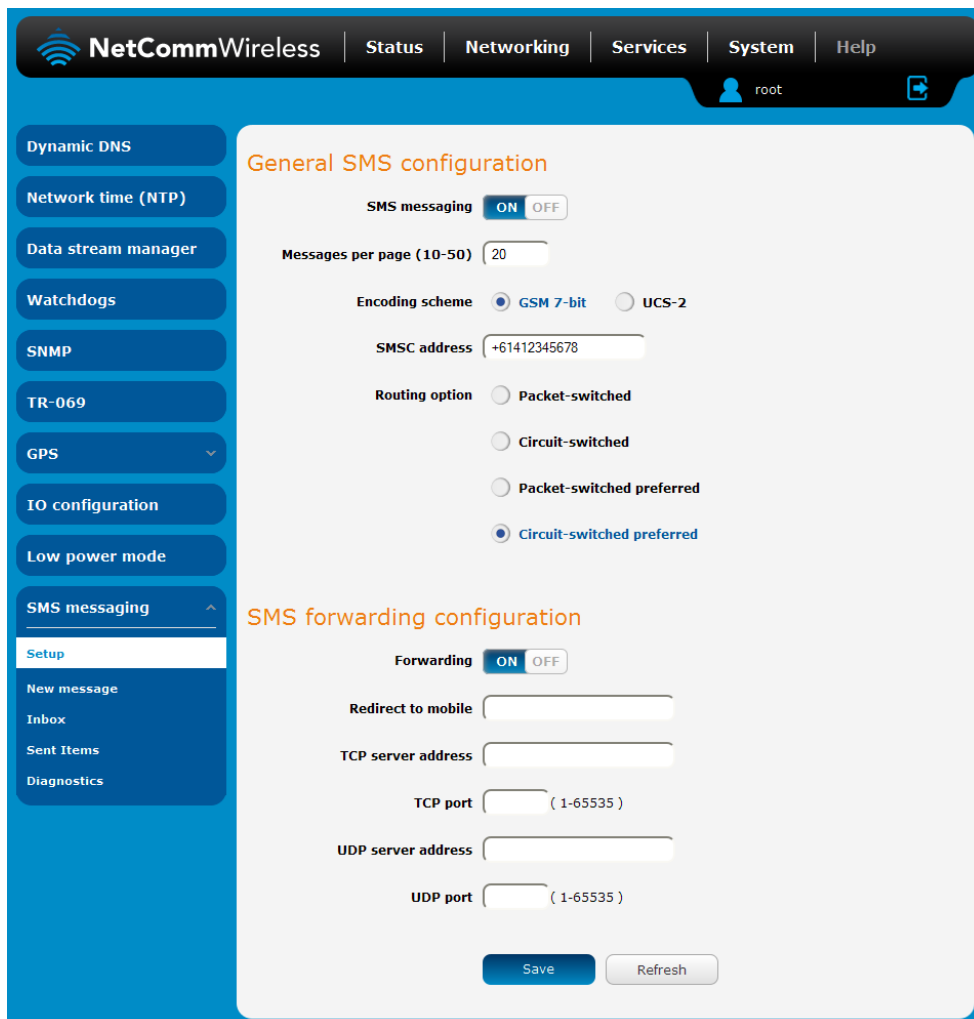

The screenshot shows the NetCommWireless web interface. The top navigation bar includes 'Status', 'Networking', 'Services', 'System', and 'Help'. The left sidebar contains various configuration options, with 'SMS messaging' selected and expanded to show 'Setup', 'New message', 'Inbox', 'Sent Items', and 'Diagnostics'. The main content area is divided into two sections:

- General SMS configuration:**
 - SMS messaging: ON OFF
 - Messages per page (10-50):
 - Encoding scheme: GSM 7-bit UCS-2
 - SMSC address:
 - Routing option: Packet-switched, Circuit-switched, Packet-switched preferred, Circuit-switched preferred
- SMS forwarding configuration:**
 - Forwarding: ON OFF
 - Redirect to mobile:
 - TCP server address:
 - TCP port: (1-65535)
 - UDP server address:
 - UDP port: (1-65535)

At the bottom of the configuration area are 'Save' and 'Refresh' buttons.

Figure 116 - General SMS Configuration

OPTION	DEFINITION
General SMS configuration	
SMS messaging	Toggles the SMS functionality of the router on and off.
Messages per page (10-50)	The number of SMS messages to display per page. Must be a value between 10 and 50.
Encoding scheme	The encoding method used for outbound SMS messages. GSM 7-bit mode permits up to 160 characters per message but drops to 50 characters if the message includes special characters. UCS-2 mode allows the sending of Unicode characters and permits a message to be up to 50 characters in length.
SMS forwarding configuration	
Forwarding	Toggles the SMS forwarding function of the router on and off.
Redirect to mobile	Enter a mobile number as the destination for forwarded SMS messages.
TCP server address	Enter an IP address or domain name as the destination for forwarded SMS messages using TCP.
TCP port	The TCP port on which to connect to the remote destination.
UDP server address	Enter an IP address or domain name as the destination for forwarded SMS messages using UDP.
UDP port	The UDP port on which to connect to the remote destination.

Table 39 - SMS Setup Settings

SMS forwarding configuration

Incoming text messages can be redirected to another mobile device and/or a TCP/UDP message server.

Redirect to mobile

You can forward incoming text messages to a different destination number. This destination number can be another mobile phone or a 3G router phone number.

For Example:

If someone sends a text message and **Redirect to mobile** is set to "+61412345678", the text message is stored on the router and forwarded to "+61412345678" at the same time.

To disable redirection to a mobile, clear the **Redirect to mobile** field and click the **Save** button.

Redirect to TCP / UDP server address

You can also forward incoming text messages to a TCP/UDP based destination. The TCP or UDP server can be any kind of public or private server if the server accepts incoming text-based messages.

The TCP/UDP address can be an IP address or domain name. The port number range is from 1 to 65535. Please refer to your TCP/UDP based SMS server configuration for which port to use.

For Example:

If someone sends a text message and **TCP server address** is set to "192.168.20.3" and **TCP port** is set to "2002", this text message is stored in the router and forwarded to "192.168.20.3" on port "2002" at the same time.

To disable redirection to a TCP or UDP address, clear the **TCP server address** and **UDP server address** fields and click the **Save** button.

New message

The New message page can be used to send SMS text messages to a single or multiple recipients.

A new SMS message can be sent to a maximum of 9 recipients at the same time. After sending the message, the result is displayed next to the destination number as “Success” or “Failure” if the message failed to send. By default, only one destination number field is displayed. Additional destination numbers may be added one at a time after entering a valid number for the current destination number field. To add a destination number, click the button and to remove the last destination in the list, click the button.

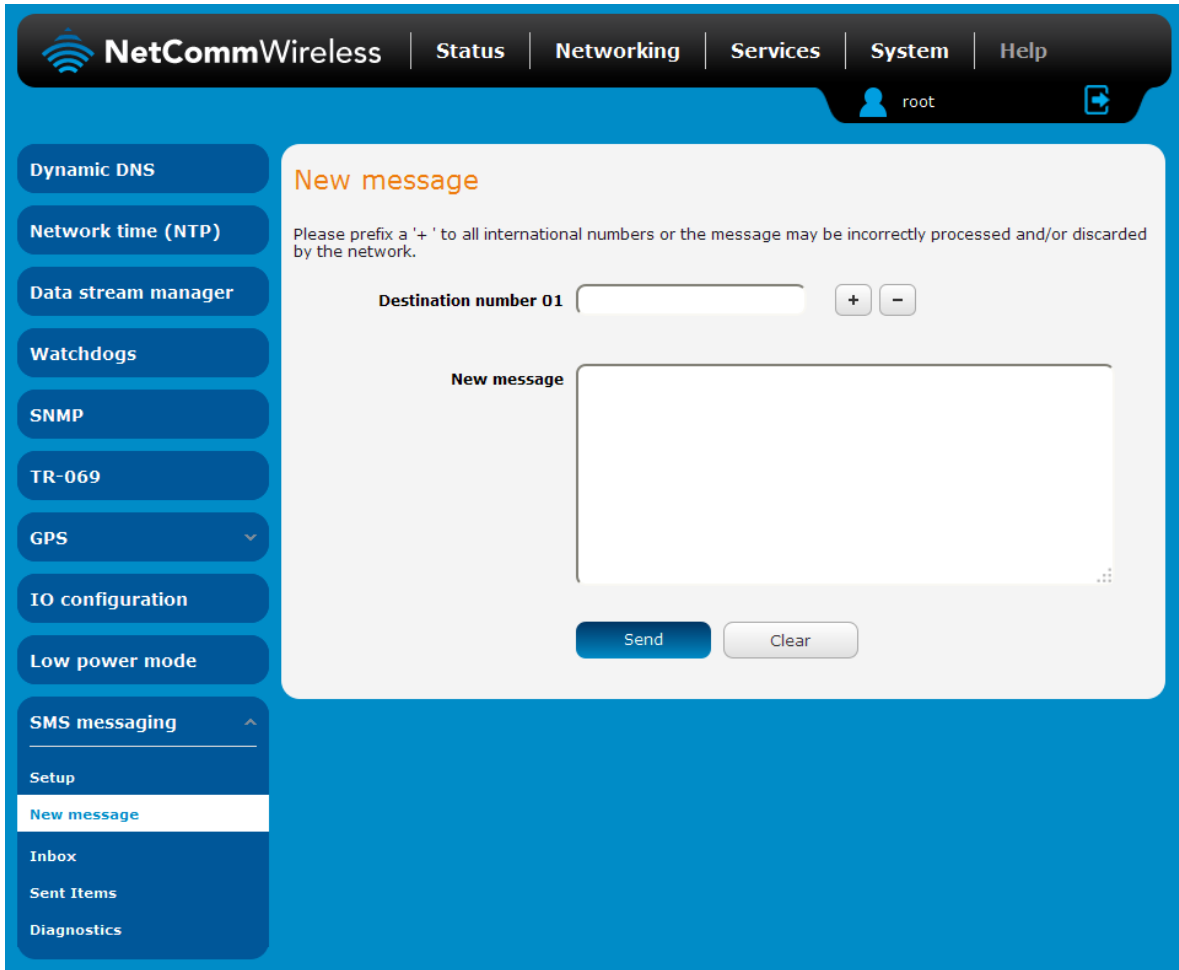

Figure 117 - SMS - New Message

Destination numbers should begin with the “+” symbol followed by the country calling code. To send a message to a destination number, enter the “+” symbol followed by the country calling code and then the destination number.

For example:

To send a message to the mobile destination number 0412345678 in Australia (country calling code 61), enter “+61412345678”.

After entering the required recipient numbers, type your SMS message in the **New message** field. As you type your message, a counter shows how many characters you have entered out of the total number available for your chosen encoding scheme. When you have finished typing your message and you are ready to send it, click the **Send** button.

Inbox / Sent Items

The Inbox displays all received messages that are stored on the router while Sent Items displays all sent messages.

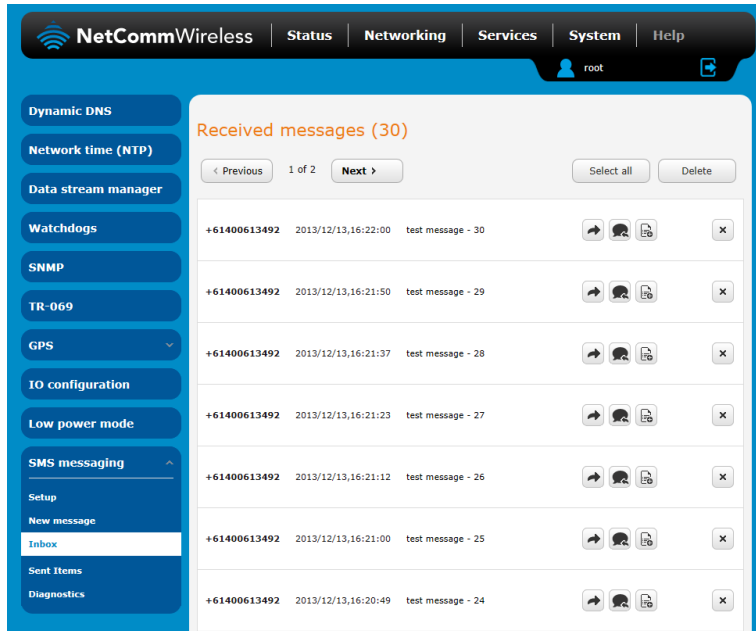

Figure 118 - SMS Inbox

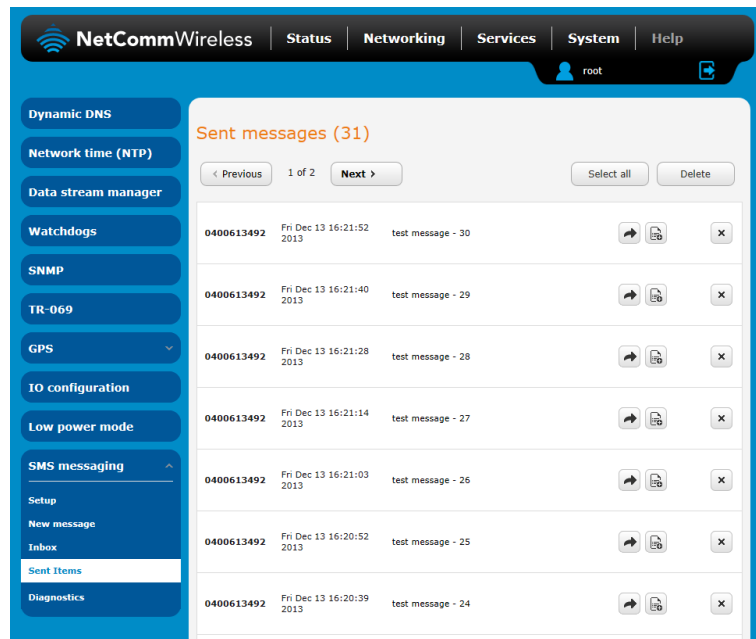

Figure 119 - SMS Outbox





ICON	DESCRIPTION
	Forward button. Click this button to open a new message window where you can forward the corresponding message to another recipient.
	Reply button. Click this button to open a new message window where you can reply to the sender.
	Add to White list. Click this button to add the sender's mobile number to the white list on the router.
	Delete button. Click this button to delete the corresponding message.
	Refresh button. Click this button to refresh the inbox or outbox to see new messages.

Table 40 - Inbox/Outbox icons

Diagnostics

The Diagnostics page is used to configure the SMS diagnostics and command execution configuration. This allows you to change the configuration, perform functions remotely and check on the status of the router via SMS commands.

To access the Diagnostics page, click on the **Services** menu item then select the **SMS** menu on the left and finally select **Diagnostics** beneath it.



SMS diagnostics and command execution configuration

Enable remote diagnostics and command execution ON OFF

Only accept authenticated SMS messages ON OFF

Send Set command acknowledgement replies ON OFF

Access advanced RDB variables ON OFF

Allow execution of advanced commands ON OFF

Send acknowledgement replies to a fixed number the sender's number

Send command error replies ON OFF

Send error replies to a fixed number the sender's number

Send a maximum number of replies per day
0 / 100 messages sent

Limit the number of diagnostic text messages that can be sent in a designated time period. Currently, the 'messages sent' count automatically resets at the start of the designated time period. For example, it will reset to zero at 01:00, 02:00, 03:00 etc for 'hour', 00:00 for 'day', 00:00 on Monday for 'week' and the first day of the month for 'month'.

White list for diagnostic or execution SMS

All incoming diagnostic or execution text messages are checked against this white list. If the message sender and password don't match any destination numbers and passwords in this white list, the message is ignored and an error message reply is sent to the sender or to a predefined destination. You can add up to 20 destination numbers via the SMS inbox/outbox pages by clicking on 'Add white list'. Alternatively, click on 'Add' below to add a number now.

The white list is empty

Figure 120 - SMS diagnostics and command execution configuration

SMS diagnostics and command execution configuration

The options on this page are described below.

Enable remote diagnostics and command execution

Enables or disables the remote diagnostics feature. If this setting is enabled all incoming text messages are parsed and tested for remote diagnostics commands.

If remote diagnostics commands are found, the router executes those commands. This feature is enabled by default. All remote diagnostic commands that are received are stored in the Inbox.



Note: It is possible to adjust settings and prevent your router from functioning correctly using remote diagnostics. If this occurs, you will need to perform a factory reset in order to restore normal operation.



We highly recommended that you use the white list and a password when utilising this feature to prevent unauthorised access. See the [White list](#) description for more information.

Only accept authenticated SMS messages

Enables or disables checking the sender's phone number against the allowed sender white list for incoming diagnostics and command execution SMS messages.

If authentication is enabled, the router will check if the sender's number exists in the white list. If it exists, the router then checks the password (if configured) in the incoming message against the password in the white list for the corresponding sending number. If they match, the diagnostic or command is executed.

If the number does not exist in the white list or the password does not match, the router does not execute the incoming diagnostic or command in the SMS message.

This is enabled by default and it is strongly advised that you leave this feature enabled to maintain security.

Send Set command acknowledgement replies

The NTC-6200 Series router will automatically reply to certain types of commands received, such as *get* commands, or *execute* commands. However acknowledgement replies from the NTC-6200 Series router are optional with *set* commands and the *Wakeup* command. This option Enables or disables sending an acknowledgment message after execution of a *set* command or SMS Wakeup command. If disabled, the router does not send any acknowledgment after execution of a *set* command or SMS Wakeup command. All acknowledgment replies are stored in the Outbox after they have been sent. This can be useful to determine if a command was received and executed by the router. This option is disabled by default.

Access advanced RDB variables

By default, this option is turned off and only allows access to the [basic RDB variables](#) listed later in this guide. If this option is enabled, you are able to access the full list of RDB variables via SMS.

Allow execution of advanced commands

By default, this option is turned off and only allows execution of the [basic commands](#) listed later in this guide. If this option is enabled, you are able to execute advanced commands such as those which are common to the Linux command line. For example: "execute ls /usr/bin/sms*" to list the contents of the /etc folder on the router.

Send acknowledgement replies to

This option allows you to specify where to send acknowledgment messages after the execution of a *set*, *get*, or *exec* command.

If a **fixed number** is selected, the acknowledgement message will be sent to the number defined in the **Fixed number to send replies** to field. If **the sender's number** is selected, the acknowledgement message will be sent to the number that the SMS diagnostic or command message originated from. The default setting is to use **the sender's number**.

Fixed number to send replies to

This field defines the destination number to which error messages are sent after the execution of a *get*, *set*, or *exec* command. This field is only displayed when **Send Error SMS to** is set to **Fixed Number**.

Send command error replies

Enables or disables the sending of an error message resulting from the execution of a *get*, *set*, or *exec* command. All error replies are stored in the Outbox after they have been sent.

Send error replies to

When **Send Error SMS for Get/Set/Exec Command** is set to **ON**, this option is used to specify where the error SMS is sent. Use the radio buttons to select either **Fixed Number** or **SMS Sender Number**. When set to **SMS Sender Number** the router will reply to the originating number of the SMS diagnostic or command. When set to **Fixed Number** the router will send the error messages to the number specified in the following field.

Send a maximum number of

You can set the maximum number of acknowledgement and error messages sent when an SMS diagnostic or command is executed. The maximum limit can be set per hour, day, week or month. The router will send a maximum of 100 replies by default.

The number of messages sent is shown below the options. The total transmitted message count resets after a reboot or at the beginning of the time frame specified.

White List for diagnostic or execution SMS

The white list is a list of mobile numbers that you can create which are considered “friendly” to the router. If **Only accept authenticated SMS messages** is enabled in the diagnostics section, the router will compare the mobile number of all incoming diagnostic and command messages against this white list to determine whether the diagnostic or command should be executed. You may optionally configure a password for each number to give an additional level of security. When a password is specified for a number, the SMS diagnostic or command message is parsed for the password and will only be executed if the number and password match.

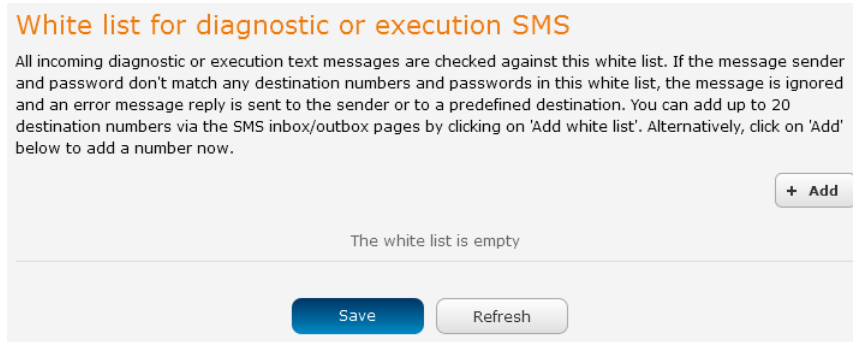

White list for diagnostic or execution SMS

All incoming diagnostic or execution text messages are checked against this white list. If the message sender and password don't match any destination numbers and passwords in this white list, the message is ignored and an error message reply is sent to the sender or to a predefined destination. You can add up to 20 destination numbers via the SMS inbox/outbox pages by clicking on 'Add white list'. Alternatively, click on 'Add' below to add a number now.

+ Add

The white list is empty

Save Refresh

Figure 121 - White list for diagnostic or execution SMS

A maximum of 20 numbers can be stored on the router in the white list. To add a number to the white list, click the “+Add” button.

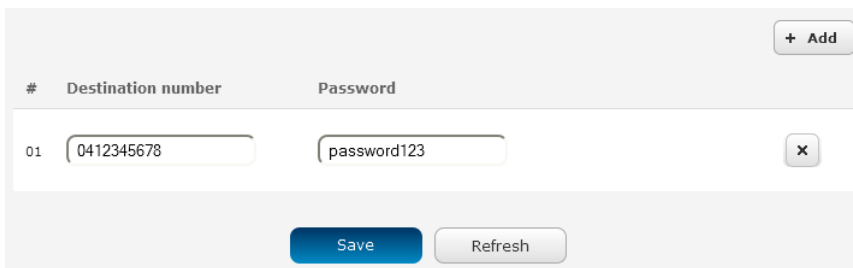

+ Add

#	Destination number	Password
01	0412345678	password123

x

Save Refresh

Figure 122 – Adding a number to the SMS white list

The White List numbers and passwords can be cleared by pressing the  button to the right of each entry. To add a number to the white list, enter it in the **Destination number** field and optionally define a password in the **Password** field. When you have finished adding numbers click the **Save** button to save the entries.

Sending an SMS Diagnostic Command

Follow the steps below to configure the router to optionally accept SMS diagnostic commands only from authenticated senders and learn how to send SMS diagnostic commands to the router.

1. Navigate to the **Services > SMS messaging > Diagnostics** page
2. Confirm that the **Enable remote diagnostics and command execution** toggle key is set to the **ON** position. If it is set to **OFF** click the toggle key to switch it to the **ON** position.
3. If you wish to have the router only accept commands from authenticated senders, ensure that **Only accept authenticated SMS messages** is set to the **ON** position. In the **White list for diagnostic or execution SMS messages** section, click the **+Add** button and enter the sender's number in international format into the **Destination number** field that appears. If you wish to also configure a password, enter the password in the **Password** field corresponding to the destination number.
4. If you would prefer to accept SMS diagnostic commands from any sender, set the **Only accept authenticated SMS messages** toggle key to the **OFF** position.





Note: An alternative method of adding a number to the white list is to send an SMS message to the router, navigate to **Services > SMS messaging > Inbox** and then click the  button next to the message which corresponds to the sender's number.



5. Click the **Save** button.

Types of SMS diagnostic commands



There are three types of commands that can be sent; **execute**, **get** and **set**. The basic syntax is as follows:

-  execute COMMAND
-  get VARIABLE
-  set VARIABLE=VALUE

If authentication is enabled, each command must be preceded by the password:

-  PASSWORD execute COMMAND
-  PASSWORD get VARIABLE
-  PASSWORD set VARIABLE=VALUE

The following are some examples of SMS diagnostic commands:

-  password6657 execute reboot
-  get rssi
-  set apn1=testAPNvalue

SMS acknowledgment replies

The router automatically replies to **get** commands with a value and **execute** commands with either a success or error response. **Set** commands will only be responded to if the **Send Set command acknowledgement replies** toggle key is set to **ON**.

SMS command format

Generic Format for reading variables:

get VARIABLE

PASSWORD get VARIABLE

Generic Format for writing to variables:

set VARIABLE=VALUE

PASSWORD set VARIABLE=VALUE

Generic Format for executing a command:

Execute COMMAND

PASSWORD execute COMMAND

Replies

Upon receipt of a successfully formatted, authenticated (if required) command, the gateway will reply to the SMS in the following format:

TYPE	SMS CONTENTS	NOTES
get command	"VARIABLE=VALUE"	
set command	"Successfully set VARIABLE to VALUE"	Only sent if the acknowledgment message function is enabled
execute command	"Successfully executed command COMMAND"	

Table 41 - SMS Diagnostic Command Syntax

Where "VARIABLE" is the name of the value to be read

Where "VARIABLE (x)" is the name of another value to be read

Where "VALUE" is the content to be written to the "VARIABLE"

Where "COMMAND" is a supported command to be executed by the device (e.g. reboot)

Where "PASSWORD" is the password (if configured) for the corresponding sender number specified in the White List

Multiple commands can be sent in the same message, if separated by a semicolon.

For Example:

get VARIABLE1; get VARIABLE2; get VARIABLE3

PASSWORD get VARIABLE1; get VARIABLE2

set VARIABLE=VALUE1 ; set VARIABLE2=VALUE2

PASSWORD set VARIABLE1=VALUE1; set VARIABLE2=VALUE2; set VARIABLE3=VALUE3

If required, values can also be bound by an apostrophe, double apostrophe or back tick.

For Example:

"set VARIABLE='VALUE'"

"set VARIABLE=""VALUE""

"set VARIABLE=`VALUE`"

"get VARIABLE"

A password (if required), only needs to be specified once per SMS, but can be prefixed to each command if desired.

“PASSWORD get Variable1”; “get VARIABLE2”

“PASSWORD set VARIABLE1=VALUE1”; “set VARIABLE2=VALUE2”

If the command sent includes the “reboot” command and has already passed the white list password check, the device keeps this password and executes the remaining command line after the reboot with this same password.

For Example:

“PASSWORD execute reboot; getVariable1”; “get VARIABLE2”

“PASSWORD execute reboot; PASSWORD get Variable1”; “get VARIABLE2”



Note: Commands, variables and values are case sensitive.

List of basic commands

A list of basic commands which can be used in conjunction with the execute command are listed below:

“pdpcycle”, “pdpdown” and “pdpup” commands can have a profile number suffix ‘x’ added. Without the suffix specified, the command operates against the default profile configured on the profile list page of the Web-UI.

#	COMMAND NAME	DESCRIPTION
1	reboot	Immediately performs a soft reboot.
2	pdpcycle	Disconnects (if connected) and reconnects the data connection. If a profile number is selected in the command, try to disconnect/reconnect the specified profile in case the profile is active. If no profile number is selected, try to disconnect/reconnect the current active profile. Reports an error if no profile number is selected and there is no currently activated profile.
3	pdpdown	Disconnects the PDP. If a profile number is selected in the command, the router tries to disconnect the specified profile in case the profile is active. If no profile number is selected, try to disconnect the current active profile. Reports an error if no profile number is selected and there is no currently activated profile.
4	pdpup	Reconnects the PDP. If a profile number is selected in the command, the router tries to connect with the specified profile. If no profile number is selected, the router tries to connect to the last active profile. The gateway will check the currently activated profile and disconnect this profile before executing the command. The router reports an error if no profile number is selected and there is no stored last active profile number.
5	factorydefaults	Performs a factory reset on the router. Be aware that this command also clears the SMS white list on the router.
6	download	Performs a download and install of a Firmware Upgrade (.cdi), Config File (.tar.gz) or a help document (.pdf) file. If the file is a firmware image as in the case of a .cdi file, the router will apply the recovery image first and then the main firmware image. The download location is specified immediately after the command and may be from an HTTP or FTP source URL. If the file is a .tar.gz file, the router will apply the file as a configuration file update for the device and reboot afterwards. If the file is a .pdf, the router will assume this is a user guide document and save it to the router and make the file available for viewing via the help menu on the Web-UI. Note: If your download URL includes any space characters, please encode these prior to transmission according to RFC1738, for example: <code>ftp://username:password@serveraddress/directory%20with%20spaces/filename.cdi</code> Note: <ul style="list-style-type: none"> The execute download command currently does not work with backups that have password protection. Authenticated FTP addresses may be used following the format as defined in RFC1738, for example: ftp://username:password@serveraddress/directory/filename.cdi
7	codconnect	Causes the router to activate the PDP context when the Connect on demand feature is enabled.
8	coddisconnect	Causes the router to de-activate the PDP context when the Connect on demand feature is enabled.
9	wakeup	This forces the default Data connection profile to connect if it is in a disconnected or waiting state. There are two circumstances in which this command may be useful; where the default profile is enabled but has been manually disconnected and if Connect on demand is enabled and the router is awaiting packet of interest. In both of these situations, the wakeup command will cause the default PDP context to activate.
10	ssh.genkeys	Instructs the router to generate new public SSH keys.

11	ssh.clearkeys	Instructs the router to clear the client public SSH key files.
----	---------------	--

Table 42 - List of basic SMS diagnostic commands

List of get/set commands

The following table is a list of get and set commands which may be performed via SMS.

COMMAND NAME	EXAMPLE	DESCRIPTION
Status		
get status	get status	Returns the Module firmware version, LAN IP Address, Network State, Network operator and RSSI.
get sessionhistory	get sessionhistory	Returns the time and date of recent sessions along with the total amount of data sent and received for each session.
Log file		
set syslogserver	set syslogserver=123.45.67.89:514	Sets a remote syslog server IP or hostname and port.
Connect on demand		
set cod	set cod=1	Enables or disables Connect on demand.
get cod	get cod	Returns the enable/disable status of the Connect on demand feature.
get codstatus	get codstatus	Returns the connection status of the Connect on demand feature.
set coddialport	set coddialport=on,53	Sets the Connect on demand feature to connect only when traffic is received on the specified port.
get coddialport	get coddialport	Returns the Connect on demand port filter status and list of filtered ports.
set codonline	set codonline=20	Sets the router to stay online for at least X minutes when data activity is detected.
get codonline	get codonline	Returns the number of minutes the router is configured to stay online when data activity is detected.
set codminonline	set codminonline=10	Sets the router to stay online for a minimum of X minutes after connecting.
get codminonline	get codminonline	Returns the minimum number of minutes the router should stay online after connecting.
set codredial	set codredial=5	Sets the number of minutes that the router should not attempt to redial after hanging up.
get codredial	get codredial	Returns the number of minutes that the router is configured to not attempt to redial after hanging up.
set coddisconnect	set coddisconnect=0	Sets the number of minutes after which the router should disconnect regardless of traffic.
get coddisconnect	get coddisconnect	Returns the number of minutes the router is configured to disconnect regardless of traffic.
set codconnectreg	set codconnectreg=30	Sets the number of minutes that the router should regularly attempt to connect.
get codconnectreg	get codconnectreg	Returns the number of minutes that the router is configured to regularly attempt to connect.
set codrandomtime	set codrandomtime=3	Sets the number of minutes that the router should randomise the dial time by.
get codrandomtime	get codrandomtime	Returns the number of minutes that the router is configured to randomise the dial time by.
set codverbose	set codverbose=1	Sets verbose logging on or off.
get codverbose	get codverbose	Returns the status of verbose logging.
set codignore.icmp	set codignore.icmp=1	Sets the router to ignore ICMP packets triggering data activity detection.
get codignore.icmp	get codignore.icmp	Returns the status of the Ignore ICMP option.
set codignore.tcp	set codignore.tcp=1	Sets the router to ignore TCP packets triggering data activity detection.
get codignore.tcp	get codignore.tcp	Returns the status of the Ignore TCP option.
set codignore.udp	set codignore.udp=1	Sets the router to ignore UDP packets triggering data activity detection.
get codignore.udp	get codignore.udp	Returns the status of the Ignore UDP option.
set codignore.dns	set codignore.dns=1	Sets the router to ignore DNS traffic triggering data activity detection.
get codignore.dns	get codignore.dns	Returns the status of the Ignore DNS option.
set codignore.ntp	set codignore.ntp=1	Sets the router to ignore NTP traffic triggering data activity detection.
get codignore.ntp	get codignore.ntp	Returns the status of the Ignore NTP option.
set codignore.ncsi	set codignore.ncsi=1	Sets the router to ignore NCSI traffic triggering data activity detection.
get codignore.ncsi	get codignore.ncsi	Returns the status of the Ignore NCSI option.
get download.timeout	get download.timeout	Returns the time in minutes that the router waits before a download times out.

set download.timeout	set download.timeout=20	Sets the time in minutes that the router waits before a download times out. This is set to 10 minutes by default. Supported range is 10 – 1440 minutes.
get install.timeout	get install.timeout	Returns the time in minutes that the router waits before a file that is being installed times out.
set install.timeout	set install.timeout=5	Sets the time in minutes that the router waits before a file that is being installed times out. This is set to 3 minutes by default. Supported range is 3 – 300 minutes.
Operator settings		
get plmnscan	get plmnscan	Instructs the router to perform a network scan and returns the results by SMS.
set forceplmn	set forceplmn=505,3	Sets the operator to a manual selection made by the user where "505" is the Mobile Country Code for Australia and "3" is the Mobile Network Code for Vodafone. As no network type (i.e. 3G or 2G) is specified, it is selected automatically.
get forceplmn	get forceplmn	Returns the operator and network type selection mode (Automatic/Manual), in addition to the MCC and MNC values
Data connection (PPPoE mode)		
get pppoe	get pppoe	Returns the PPPoE status, currently configured dial string and service name
set pppoe	set pppoe=1, telstra.internet, test	Sets the PPPoE status on, APN to telstra.internet, and service name to test.
LED operation mode		
get ledmode	get ledmode	Returns the status of the LED operation mode.
set ledmode	set ledmode=10	Sets the LED operation mode to be always on or to turn off after the specified number of minutes.
SSH key management		
get ssh.proto	get ssh.proto	Returns the SSH protocol in use.
set ssh.proto	set ssh.proto=1,2	Sets the SSH Protocol to protocol 1, 2 or both (1,2).
get ssh.passauth	get ssh.passauth	Returns the status of the SSH Enable password authentication option.
set ssh.passauth	set ssh.passauth=1	Sets the SSH Enable password authentication option on or off.
get ssh.keyauth	get ssh.keyauth	Returns the status of the SSH Enable key authentication option.
set ssh.keyauth	set ssh.keyauth=1	Sets the SSH Enable key authentication option on or off.

Table 43 - List of get/set commands



Note: Get/set commands may also be performed on many RDB variables. To obtain a full list of RDB variables, refer to [Appendix H](#).

List of basic RDB variables

The following table lists valid variables where “x” is a profile number (1-6). If no profile is specified, variables are read from or written to for the current active profile. If a profile is specified, variables are read from or written to for the specified profile number ('x').

#	RDB VARIABLE NAME	SMS VARIABLE NAME	READ/ WRITE	DESCRIPTION	EXAMPLE VALUE
0	link.profile.1.enable link.profile.1.apn link.profile.1.user link.profile.1.pass link.profile.1.auth_type link.profile.1.iplocal link.profile.1.status	profile	RW	Profile	Read: (profile no,apn,user,pass,auth,iplocal,status) 1,apn,username,password, chap,202.44.185.111,up Write: (apn, user, pass,auth) apn,username,password
2	link.profile.1.user	username	RW	3G username	Guest, could also return “null”
3	link.profile.1.pass	password	RW	3G password	Guest, could also return “null”
4	link.profile.1.auth_type	authtype	RW	3G Authentication type	“pap” or “chap”
5	link.profile.1.iplocal	wanip	R	WAN IP address	202.44.185.111
6	wwan.0.radio.information.signal_strength	rsi	R	3G signal strength	-65 dBm
7	wwan.0.imei	imei	R	IMEI number	357347050000177
8	statistics.usage_current	usage	R	3G data usage of current session	“Rx 500 bytes, Tx 1024 bytes, Total 1524 bytes” or “Rx 0 byte, Tx 0 byte, Total 0 byte” when wwan down
9	statistics.usage_current	wanuptime	R	Up time of current 3G session	1 days 02:30:12 or 0 days 00:00:00 when wwan down
10	/proc/uptime	deviceuptime	R	Device up time	1 days 02:30:12
11	wwan.0.system_network_status.current_band	band	R	Current band	WCDMA850





Table 44 - List of basic SMS diagnostics RDB variables

Network scan and manual network selection by SMS

Performing a network scan

The **get plmnscan** SMS command enables you to perform a scan of the cellular networks available at the time of the scan.

It returns the following semi-colon separated information for each network in range:

-  MCC
-  MNC
-  Network Type (3G, 2G)
-  Provider's Name
-  Operator Status (available, forbidden, current)

The following is an example of a response from the **get plmnscan** SMS command:

plmnscan:505,3,7,vodafone AU,4;505,3,1,vodafone AU,1;505,2,7,YES OPTUS,1;505,2,1,YES OPTUS,1;505,1,1,Telstra Mobile,1;505,1,7,Telstra Mobile,1

NETWORK TYPE	DESCRIPTION
7	Indicates a 3G network
1	Indicates a 2G network

Table 45 - Network types returned by get plmnscan SMS command

OPERATOR STATUS	DESCRIPTION
1	Indicates an available operator which may be selected.
2	Indicates a forbidden operator which may not be selected (applies only to generic SIM cards).
4	Indicates the currently selected operator.

Table 46 - Operator status codes returned by get plmnscan SMS command



Notes about the network connection status when using the **get plmnscan** command:

- If the connection status is **Up** and connection mode is **Always on**, the **get plmnscan** SMS will cause the connection to disconnect, perform the scan, send the result through SMS and then bring the connection back up again. If the connection status is **Down**, the router will perform the PLMN scan, send the result and keep the connection status down.
- If the connection status is **Waiting** and connection mode is **Connect on demand**, the **get plmnscan** SMS will change the connection status to **Down**, perform the scan, send the result through SMS and then restore the connection status to the **Waiting** state.
- If the connection status is **Up** and connection mode is **Connect on demand**, the **get plmnscan** SMS will cause the connection to disconnect, perform the scan, send the result through SMS, and then restore the connection status to the **Waiting** state unless there is a traffic which triggers a connection in which case the connection status will be set to **Up**.

Setting the router to connect to a network

The router can be instructed by SMS to connect to one of the networks returned by the **get plmnscan** command. The **set forceplmn** command forces the router to connect to a specified operator network (if available) while the **get forceplmn** command retrieves the currently configured network on the router.

Command format:

```
set forceplmn=0|MCC,MNC| MCC,MNC,Network Type
```

For example:

```
set forceplmn=0
```

Sets the selection of operator and network type to automatic mode.

```
set forceplmn=505,3
```

Sets the operator to a manual selection made by the user where "505" is the Mobile Country Code for Australia and "3" is the Mobile Network Code for Vodafone. As no network type (i.e. 3G or 2G) is specified, it is selected automatically.

```
set forceplmn=505,3,7
```

Sets the operator and network type to a manual selection made by the user where "505" is the Mobile Country Code for Australia, "3" is the Mobile Network Code for Vodafone and "7" is the 3G network type.



Notes about the **set forceplmn** command:

1. If the manual selection fails, the device will fall back to the previous 'good' network.
2. When enabled, the SMS acknowledgement reply reflects the success or failure of the manual selection with respect to the *set* command and includes the final MNC/MCC that was configured.

Confirming the currently configured operator and network type

You can retrieve the currently configured operator and network type using the **get forceplmn** command.

The **get forceplmn** command returns the operator and network type selection mode (Automatic/Manual), in addition to the MCC and MNC values, for example:

Automatic,505,3

This response indicates that the operator/network selection mode is Automatic, and the network used is Vodafone AU.

SMS diagnostics examples

The examples below demonstrate various combinations of supported commands. This is not an exhaustive list and serves as an example of possibilities only.

DESCRIPTION	AUTHENTICATION	INPUT EXAMPLE
Send SMS to change the data connection username	Not required	set username='NetComm'
	Required	PASSWORD set username= "NetComm"
Send SMS to change the data connection password	Not required	set password= 'NetComm'
	Required	PASSWORD set password= 'NetComm'
Send SMS to change the data connection authentication	Not required	set authtype= 'pap'
	Required	PASSWORD set authtype = pap
Send SMS to reboot	Not required	execute reboot
	Required	PASSWORD execute reboot
Send SMS to check the WAN IP address	Not required	get wanip
	Required	PASSWORD get wanip
Send SMS to check the mobile signal strength	Not required	get rssi
	Required	PASSWORD get rssi
Send SMS to check the IMEI number	Not required	get imei
	Required	PASSWORD get imei
Send SMS to check the current band	Not required	get band
	Required	PASSWORD get band
Send SMS to Disconnect (if connected) and reconnect the data connection	Not required	execute pdpcycle
	Required	PASSWORD execute pdpcycle
Send SMS to disconnect the data connection	Not required	execute pdpdown
	Required	PASSWORD execute pdpdown
Send SMS to connect the data connection	Not required	execute pdpup
	Required	PASSWORD execute pdpup
Send multiple get command	Not required	get wanip; get rssi
	Required	PASSWORD get wanip; get rssi
Send multiple set command	Not required	set ssh.genkeys=1; set username=test; set auth=pap
	Required	PASSWORD set ssh.genkeys=1; set username=test; set auth=pap
Send SMS to reset to factory default settings	Not required	execute factorydefaults
	Required	PASSWORD execute factorydefaults
Send SMS to retrieve status of router	Not required	get status
	Required	PASSWORD get status
	Not required	get sessionhistory

Send SMS to retrieve the history of the session, including start time, end time and total data usage	Required	PASSWORD get sessionhistory
Send SMS to configure the router to send syslog to a remote syslog server	Not required	set syslogserver=123.209.56.78
	Required	PASSWORD set syslogserver=123.209.56.78
Send SMS to wake up the router, turn on the default gateway and trigger the 'connect on demand' profile if in waiting state.	Not required	execute wakeup
	Required	PASSWORD execute wakeup
Send SMS to perform firmware upgrade when firmware is located on HTTP server	Not required	execute download http://download.com:8080/firmware_image.cdi execute download http://download.com:8080/firmware_image_r.cdi
	Required	PASSWORD execute download http://download.com:8080/firmware_image.cdi PASSWORD execute download http://download.com:8080/firmware_image_r.cdi
Send SMS to perform firmware upgrade when firmware is located on FTP server	Not required	execute download ftp://username:password@download.com/firmware_image.cdi execute download ftp://username:password@download.com/firmware_image_r.cdi
	Required	PASSWORD execute download ftp://username:password@download.com/firmware_image.cdi PASSWORD execute download ftp://username:password@download.com/firmware_image_r.cdi
Send SMS to download and install IPK package located on HTTP server	Not required	execute download http://download.com:8080/package.ipk
	Required	PASSWORD execute download http://download.com:8080/package.ipk
Send SMS to download and install IPK package located on FTP server	Not required	execute download ftp://username:password@download.com:8080/package.ipk
	Required	PASSWORD execute download ftp://username:password@download.com:8080/package.ipk
Send SMS to turn off PPPoE	Not required	set pppoe=0
	Required	PASSWORD set pppoe=0
Send SMS to retrieve the PPPoE status, currently configured dial string and service name	Not required	get pppoe
	Required	PASSWORD get pppoe
Send SMS to set the LED mode timeout to 10 minutes	Not required	set ledmode=10
	Required	PASSWORD set ledmode=10
Send SMS to retrieve the current LED mode	Not required	get ledmode
	Required	PASSWORD get ledmode
Retrieve current SSH protocol	Not required	get ssh.proto
	Required	PASSWORD get ssh.proto
Select SSH protocol	Not required	set ssh.proto=1
	Required	PASSWORD set ssh.proto=1
Retrieve password authentication status	Not required	get ssh.passauth
	Required	PASSWORD get ssh.passauth
Enable/disable password authentication on host	Not required	set ssh.passauth=1 or set ssh.passauth=0
	Required	PASSWORD set ssh.passauth=1 or PASSWORD set ssh.passauth=0
Generate set of public/private keys on the host	Not required	execute ssh.genkeys
	Required	PASSWORD execute ssh.genkeys
Clear client public keys stored on host	Not required	execute ssh.clearkeys
	Required	PASSWORD execute ssh.clearkeys

Table 47 - SMS diagnostics example commands

System

Log

The Log pages are used to display or download the System log, IPSec log and Event notification logs on the router.

System log

The System Log enables you to troubleshoot any issues you may be experiencing with your NTC-6200 Series router. To access the System Log page, click on the **System** menu. The System Log is displayed.

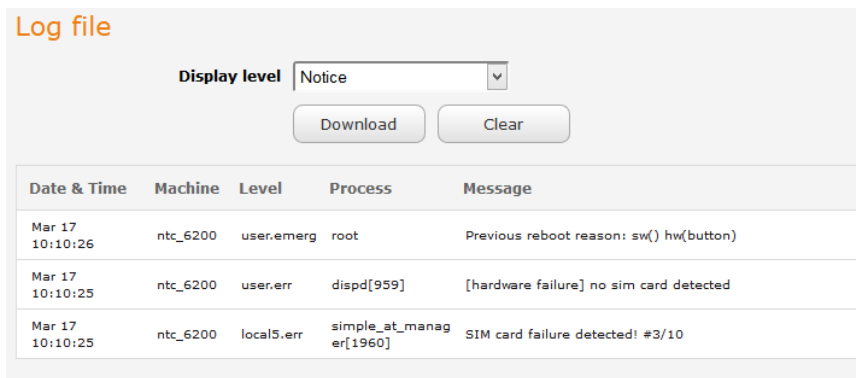

Figure 123 - System log file

Log file

Use the **Display level** drop-down list to select a message level to be displayed. The message levels are described in the table below. To download the System log for offline viewing, right-click the **Download** button and choose **Save as..** to save the file. To clear the System log, click the **Clear** button. The downloaded log file is in Linux text format with carriage return (CR) only at the end of a line, therefore in order to be displayed correctly with new lines shown, it is recommended to use a text file viewer which displays this format correctly (e.g. Notepad++).

IPSec log

The IPSec log section provides the ability for you to download the log for the IPSec VPN function. This can assist in troubleshooting any problems you may have with the IPSec VPN.

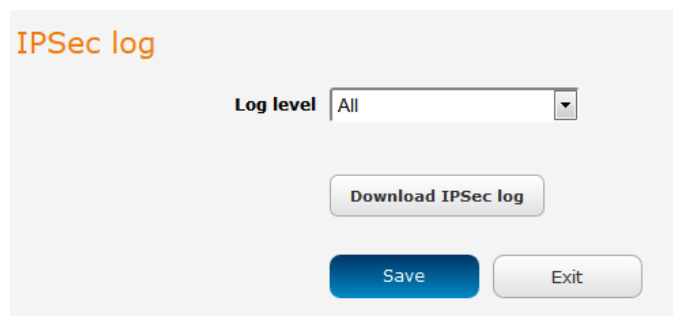

Figure 124 - IPSec log

Use the **Log level** drop down list to specify the type of detail you want to capture in the log and then click the **Save** button. When you change the logging level, any active IPSec VPN tunnels will be disconnected as a change in logging level requires the IPSec service to be restarted.

To download the IPSec log, click the **Download IPSec log** button and you will be prompted to save the file.

Event notification log

The Event notification log section provides the ability for you to download the log for the Event notification function. This can assist in troubleshooting any problems you may have with the Event notification feature.

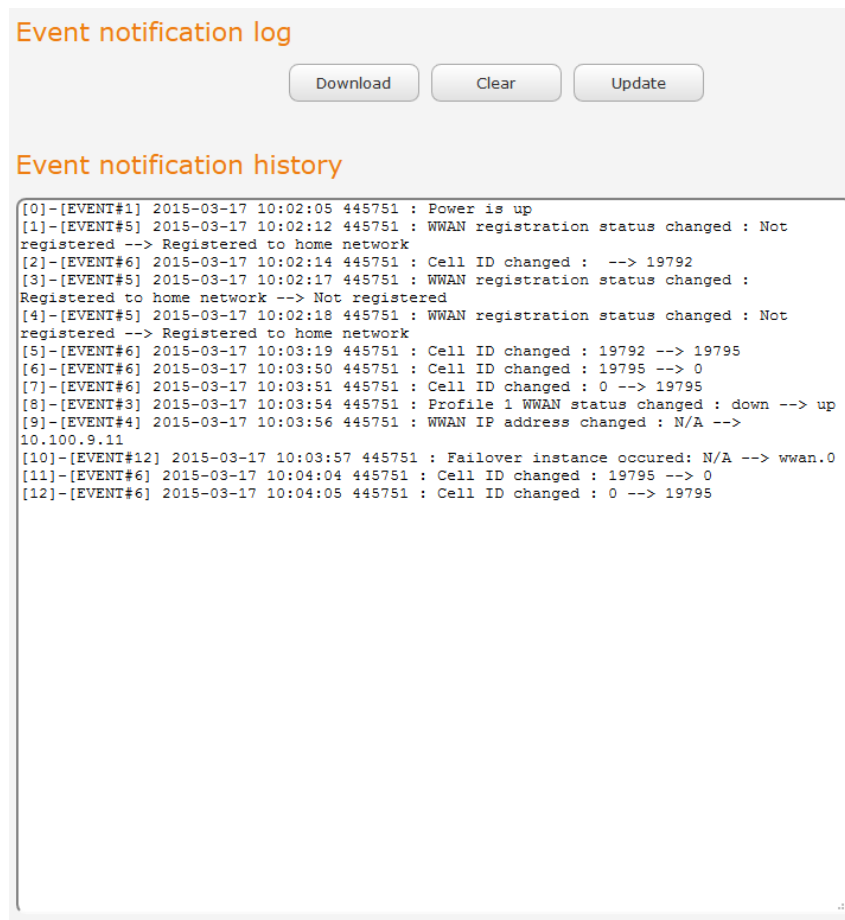

Event notification log

Download Clear Update

Event notification history

```
[0]-[EVENT#1] 2015-03-17 10:02:05 445751 : Power is up
[1]-[EVENT#5] 2015-03-17 10:02:12 445751 : WWAN registration status changed : Not
registered --> Registered to home network
[2]-[EVENT#6] 2015-03-17 10:02:14 445751 : Cell ID changed : --> 19792
[3]-[EVENT#5] 2015-03-17 10:02:17 445751 : WWAN registration status changed :
Registered to home network --> Not registered
[4]-[EVENT#5] 2015-03-17 10:02:18 445751 : WWAN registration status changed : Not
registered --> Registered to home network
[5]-[EVENT#6] 2015-03-17 10:03:19 445751 : Cell ID changed : 19792 --> 19795
[6]-[EVENT#6] 2015-03-17 10:03:50 445751 : Cell ID changed : 19795 --> 0
[7]-[EVENT#6] 2015-03-17 10:03:51 445751 : Cell ID changed : 0 --> 19795
[8]-[EVENT#3] 2015-03-17 10:03:54 445751 : Profile 1 WWAN status changed : down --> up
[9]-[EVENT#4] 2015-03-17 10:03:56 445751 : WWAN IP address changed : N/A -->
10.100.9.11
[10]-[EVENT#12] 2015-03-17 10:03:57 445751 : Failover instance occurred: N/A --> wwan.0
[11]-[EVENT#6] 2015-03-17 10:04:04 445751 : Cell ID changed : 19795 --> 0
[12]-[EVENT#6] 2015-03-17 10:04:05 445751 : Cell ID changed : 0 --> 19795
```

Figure 125 - Event notification log

Use the **Download event notification history** button to download the log file. The **Update event notification history** button forces a refresh of the log display.

System log settings

To access the System log settings page, click on the **System** menu item then select the **Log** menu on the left and finally select **System log settings** beneath it.

Log data is stored in RAM and therefore, when the unit loses power or is rebooted, it will lose any log information stored in RAM. To ensure that log information is accessible between reboots of the router there are two options:

1. Enable the **Log to non-volatile memory** option
2. Use a remote syslog server

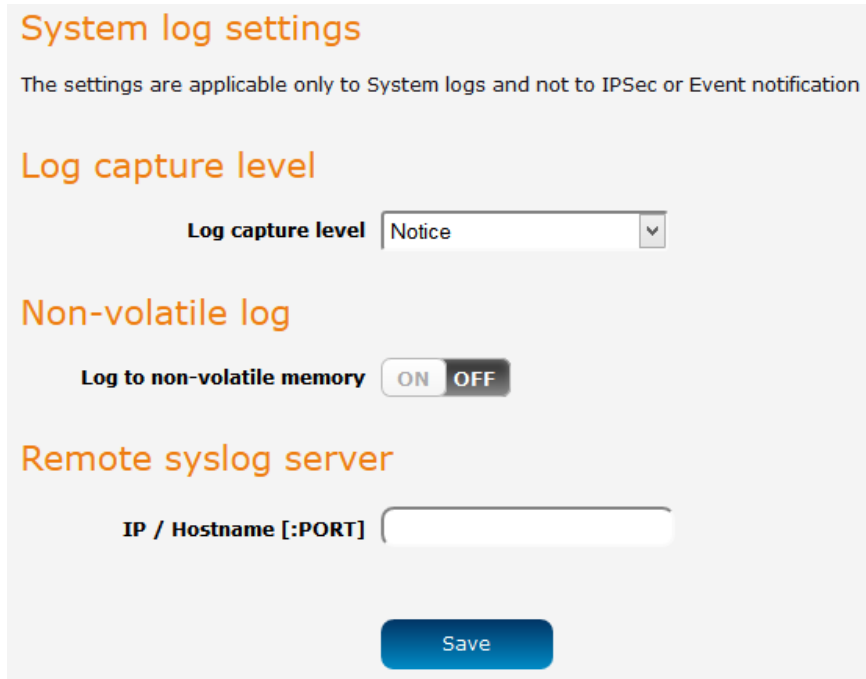

Figure 126 - System log settings

Non-volatile log

When the router is configured to log to non-volatile memory, the log data is stored in flash memory, making it accessible after a reboot of the router. Up to 512kb of log data will be stored before it is overwritten by new log data. Flash memory has a finite number of program-erase operations that it may perform to the blocks of memory. While this number of program-erase operations is quite large, we recommend that you do not enable this option for anything other than debugging to avoid excessive wear on the memory.

Log capture level

The log capture level defines the amount of detail that the system log stores. This setting also affects the Display level setting on the System log page, for example, if this is set to a low level, such as “Error”, the System log will not be able to display higher log levels.

Remote syslog server

The router can be configured to output log data to a remote syslog server. This is an application running on a remote computer which accepts and displays the log data. Most syslog servers can also save the log data to a file on the computer on which it is running allowing you to ensure that no log data is lost between reboots.

To configure the NTC-6200 Series router to output log data to a remote syslog server:

3. Click on the **System** menu from the top menu bar. The System log item is displayed.
4. Under the **Remote syslog server** section, enter the IP address or hostname of the syslog server in the **IP / Hostname [PORT]** field. You can also specify the port number after the IP or hostname by entering a semi-colon and then the port number e.g. 192.168.1.102:514. If you do not specify a port number, the router will use the default UDP port 514.
5. Click the **Save** button to save the configuration.

Remote syslog server

IP / Hostname [:PORT]

Save

Figure 127 – Remote syslog server configuration

ITEM	DEFINITION
Debug	Show extended system log messages with full debugging level details.
Info	Show informational messages only.
Notice	Show normal system logging information.
Error	Show error condition messages only.

Table 48 - System log detail levels

System configuration

Settings backup and restore

The settings backup and restore page is used to backup or restore the router's configuration or to reset it to factory defaults. In order to view the settings page you must be logged into the web user interface as **root** using the password **admin**. The backup / restore functions can be used to easily configure a large number of NTC-6200 Series router by configuring one router with your desired settings, backing them up to a file and then restoring that file to multiple NTC-6200 Series routers.

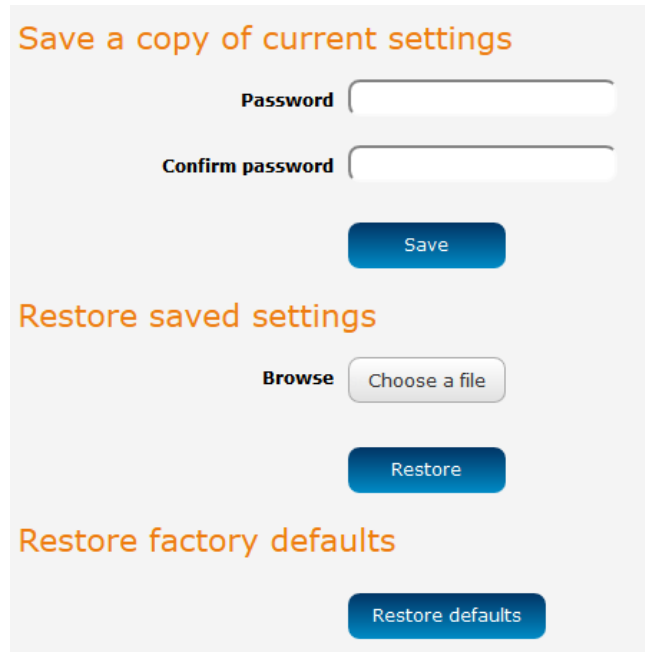

The screenshot shows a web interface for settings backup and restore. It is divided into three sections:

- Save a copy of current settings:** Contains two input fields labeled "Password" and "Confirm password", followed by a blue "Save" button.
- Restore saved settings:** Contains a "Browse" label next to a "Choose a file" button, followed by a blue "Restore" button.
- Restore factory defaults:** Contains a blue "Restore defaults" button.

Figure 128 – Settings backup and restore

Back up your router's configuration

Log in to the web configuration interface, click on the **System** menu and select **Settings backup and restore**.

If you want to password protect your backup configuration files, enter your password in the fields under **Save a copy of current settings** and click on **Save**. If you don't want to password protect your files, just click on **Save**. The router will then prompt you to select a location to save the settings file.



Note: The following conditions apply:-

- It is NOT possible to edit the contents of the file downloaded; if you modify the contents of the configuration file in any way you will not be able to restore it later.
- You may change the name of the file if you wish but the filename extension must remain as ".cfg"

Restore your backup configuration

1. In the web configuration interface click on the **System** menu and select **Settings backup and restore**.
2. From the **Restore saved settings** section, click on **Browse** or **Choose a file** and select the backup configuration file on your computer.
3. Click **Restore** to copy the settings to the new NTC-6200 Series router. The router will apply these settings and inform you it will reboot - click on **OK**.

Restoring the router's factory default configuration

Click the **Restore defaults** button to restore the factory default configuration. The router asks you to confirm that you wish to restore factory default settings. If you wish to continue with the restoring of factory defaults, click **OK**.



Note: All current settings on the router will be lost when performing a restore of factory default settings. The device IP address will change to 192.168.1.1 and the default username **root** and default password **admin** will be configured.

Upload

To access the Upload page, click on the **System** menu, then **System Configuration** and then **Upload**.

The Upload page allows you to upload firmware files, HTTPS certificates or user created application packages to the NTC-6200 Series router. When firmware files have been uploaded, they can also be installed from this page. PDF files, such as this user guide may also be uploaded for access on the router's help page.

For more information on application development, contact NetComm Wireless about our Software Development Kit.

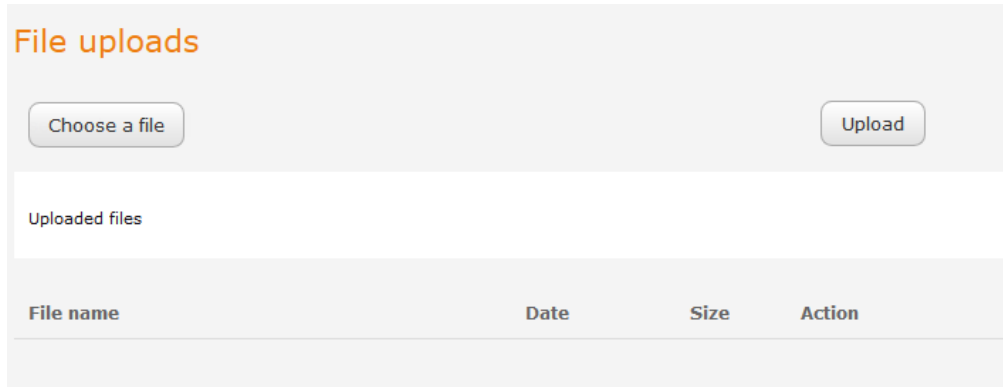

Figure 129 - Upload page

Updating the Firmware



Note: In order to perform an update, you must be logged into the router with the root manager account (see the [Advanced configuration](#) section for more details).

To update the NTC-6200 router's firmware:

1. Power on the router as described in the [Installing the router](#) section.
2. Log in to the router with the root user account (See the [Advanced configuration](#) section for details)
3. Select the **System** item from the top menu bar, select the **System configuration** item from the menu on the left and then select the **Upload** menu item.
4. Under the **File uploads** section, click the **Choose a file** button. Locate the firmware image file on your computer and click **Open**.
5. Click the **Upload** button. The firmware image is uploaded to the storage on the router.

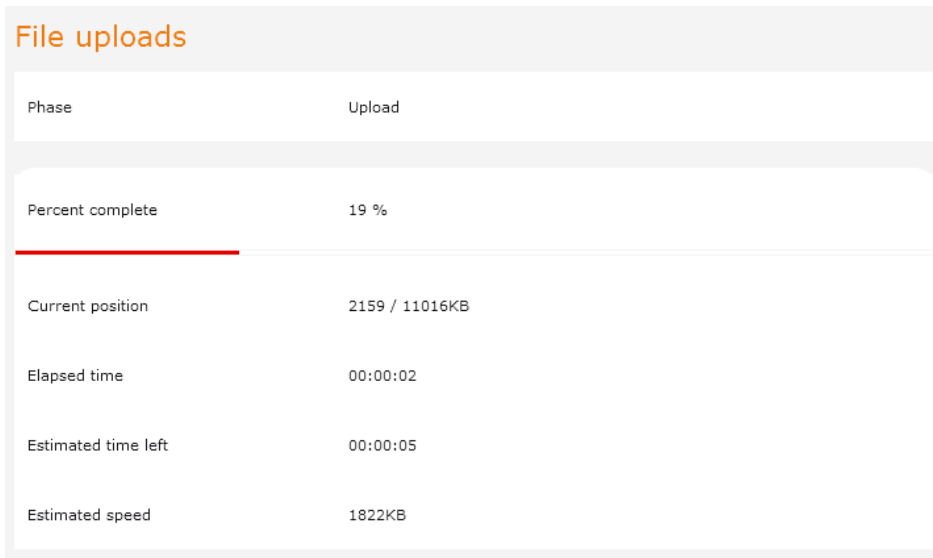

Figure 130 - File upload

- The uploaded firmware image is listed in the **Uploaded files** section. Click the **Install** link next to the firmware image to begin installation and then click **OK** on the confirmation window that appears.

File name	Date	Size	Action
ntc_6200_vX.XX.XX.X.cdi	Dec 18 2013	31.0M	Install Delete
ntc_6200_vX.XX.XX.X_r.cdi	Dec 18 2013	12.6M	Install Delete

Figure 131 - Uploaded files

- Click the **Install** link to the right of the firmware image you uploaded and then click **OK** to confirm that you want to continue with the installation.



Note: Do not remove the power when the router's LEDs are flashing as this is when the firmware update is in process.

- The installation is complete when the countdown reaches zero. The router attempts to redirect you to the Status page.

```

Writing data to block 190 at offset 0x17c0000
Writing data to block 191 at offset 0x17e0000
Writing data to block 192 at offset 0x1800000
Writing data to block 193 at offset 0x1820000
Writing data to block 194 at offset 0x1840000
Done
Done
Done
The firmware update was successful Reboot to main system...
Estimated time remaining: 47 seconds
Estimated time remaining: 42 seconds
Estimated time remaining: 37 seconds
Estimated time remaining: 32 seconds
Estimated time remaining: 27 seconds
Estimated time remaining: 22 seconds
Estimated time remaining: 17 seconds
Estimated time remaining: 12 seconds
Estimated time remaining: 7 seconds
Estimated time remaining: 2 seconds
Redirecting you to the Status page...
    
```

Close

Figure 132 -- Installing main firmware image

- Hold down the reset button on the router for 15-20 seconds to reboot and restore the factory default settings of the router. See the [Restoring factory default settings](#) section for more information.

Package manager

The Package Manager page is used to provide details of any user installed packages on the router and allow them to be uninstalled. For more information on application development, contact NetComm Wireless about our Software Development Kit.

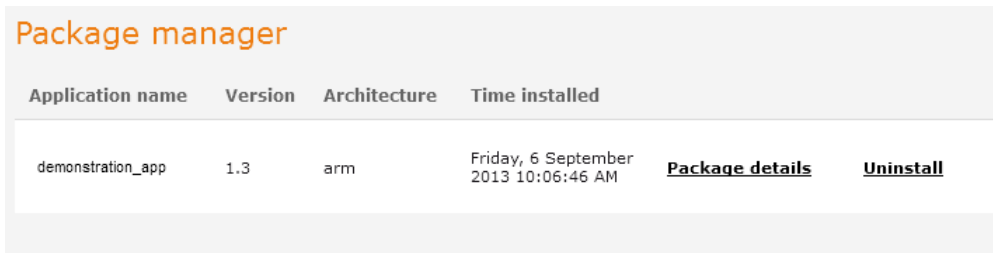

Application name	Version	Architecture	Time installed		
demonstration_app	1.3	arm	Friday, 6 September 2013 10:06:46 AM	Package details	Uninstall

Figure 133 – Software applications manager

The Application name, Version number of the application, the architecture type and time of installation are all displayed. Clicking the [Package details](#) link will display a pop-up window with further details of the package.

To uninstall any software applications, click the [Uninstall](#) link.

Administration

Administration settings

To access the Administration Settings page, click on the **System** menu then the **Administration** menu on the left and then click on **Administration Settings**.

The Administration settings page is used to enable or disable protocols used for remote access and configure the passwords for the user accounts used to log in to the router.

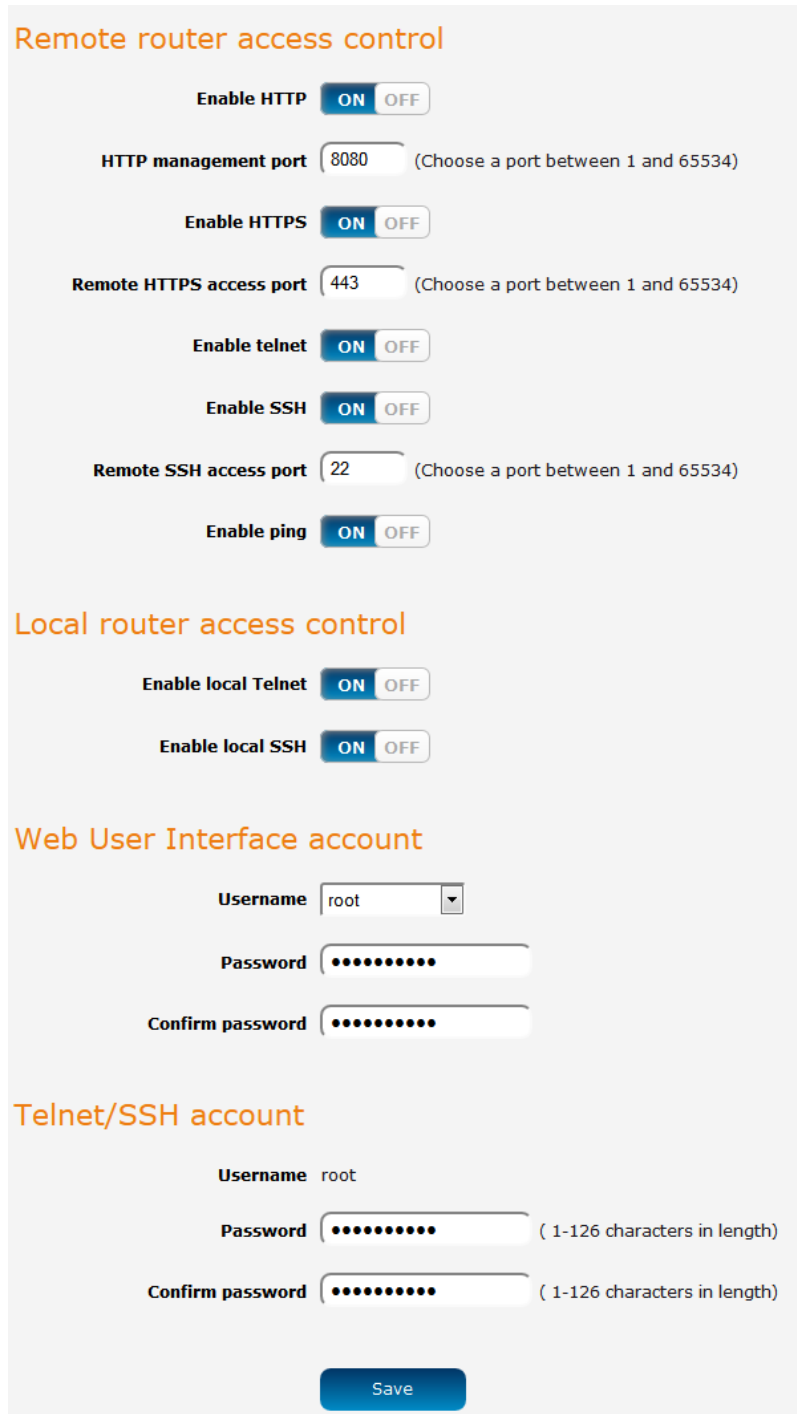

Remote router access control

Enable HTTP ON OFF

HTTP management port (Choose a port between 1 and 65534)

Enable HTTPS ON OFF

Remote HTTPS access port (Choose a port between 1 and 65534)

Enable telnet ON OFF

Enable SSH ON OFF

Remote SSH access port (Choose a port between 1 and 65534)

Enable ping ON OFF

Local router access control

Enable local Telnet ON OFF

Enable local SSH ON OFF

Web User Interface account

Username

Password

Confirm password

Telnet/SSH account

Username root

Password (1-126 characters in length)

Confirm password (1-126 characters in length)

Figure 134 - Administration page

OPTION	DEFINITION
Remote router access control	
Enable HTTP	Enable or disable remote HTTP access to the router. You can also set the port you would like remote HTTP access to be available on.
HTTP management port	Enter a port number between 1 and 65534 to use when accessing the router remotely.
Enable HTTPS	Enable or disable remote HTTPS access to the router using a secure connection.
Remote HTTPS access port	Enter a port number between 1 and 65534 to use when accessing the router remotely over a secure HTTPS connection.
Enable Telnet	Enable or disable remote telnet (command line) access to the router.
Enable SSH	Enable or disable Secure Shell on the router.
Remote SSH Access Port	Enter the port number for remote SSH access. Must be a port number between 1 and 65534.
Enable Ping	Enable or disable remote ping responses on the WWAN connection.
Local router access control (Telnet/SSH)	
Web User Interface account	
Username	Use the drop down list to select the root or admin account to change its web user interface password.
Password	Enter the desired web user interface password.
Confirm password	Re-enter the desired web user interface password.
Telnet/SSH account	
Username	Displays the Telnet/SSH.username. This may not be changed.
Password	Enter the desired Telnet/SSH password.
Confirm password	Re-enter the desired Telnet/SSH password.

Table 49 - Administration configuration options

To access the router's configuration pages remotely:

1. Open a new browser window and navigate to the WAN IP address and assigned port number of the router, for example <http://123.209.130.249:8080>



Note: You can find the router's WAN IP address by clicking on the "Status" menu. The WWAN IP field in the WWAN Connection Status section shows the router's WAN IP address.

2. Enter the username and password to log in to the router and click **Log in**.



Note: To perform functions like Firmware upgrade, device configuration backup and to restore and reset the router to factory defaults, you must be logged in with the root manager account.



WARNING: Using an insecure password will result in your device being compromised. Any resulting damage may not be covered under warranty. It is strongly advised that the password not be a dictionary word, nor should the same password be used across fleets of devices.

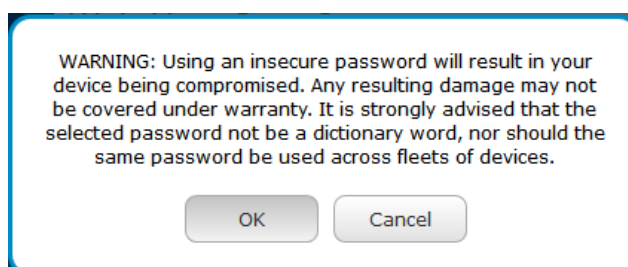

Server certificate

What is HTTP Secure?

HTTP Secure or HTTPS is the use of the HTTP protocol over an SSL/TLS protocol. It is used primarily to protect against eavesdropping of communication between a web browser and the web site to which it is connected. This is especially important when you wish to have a secure connection over a public network such as the internet. HTTPS connections are secured through the use of certificates issued by trusted certificate authorities such as VeriSign. When a web browser makes a connection attempt to a secured web site, a digital certificate is sent to the browser so that it can verify the authenticity of the site using a built-in list of trusted certificate authorities.

There are two main differences between how HTTPS and HTTP connections work:

1. HTTPS uses port 443 while HTTP uses port 80 by default.
2. Over an HTTPS connection, all data sent and received is encrypted with SSL while over an HTTP connection, all data is sent unencrypted.

The encryption is achieved through the use of a pair of public and private keys on both sides of the connection. In cryptography, a key refers to a numerical value used by an algorithm to alter information (encrypt it), making the information secure and visible only to those who have the corresponding key to recover (decrypt) the information. The public key is used to encrypt information and can be distributed freely. The private key is used to decrypt information and must be secret by its owner.

Each NTC-6200 Series router contains a self-signed digital certificate which is identical on all NTC-6200 Series routers. For a greater level of security, the router also supports generating your own unique key. Additionally, you may use third party software to generate your own self-signed digital certificate or purchase a signed certificate from a trusted certificate authority and then upload those certificates to the router.

Generating your own self-signed certificate

To generate your own self-signed certificate:

1. Click the **System** item from the top menu bar, then **Administration** from the side menu bar and then **Server certificate**.
2. Select a **Server key size**. A larger key size takes longer to generate but provides better security.
3. Click the **Generate** button to begin generating Diffie-Hellman parameters.
4. Enter the certificate details using the appropriate fields. Each field must be completed in order to generate a certificate.

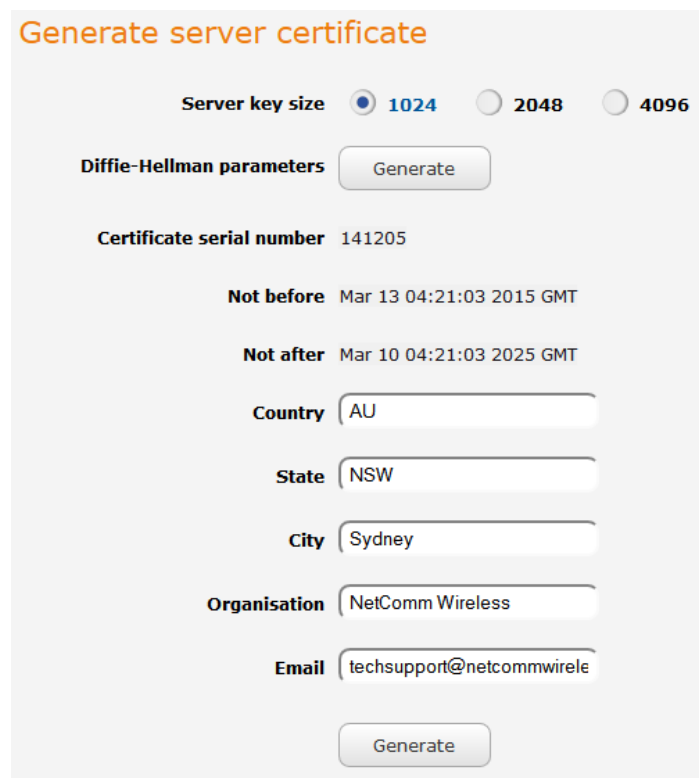

Figure 135 - Generate server certificate



Note: The **Country** field must contain a code for the desired country from the list below.

CODE	COUNTRY	CODE	COUNTRY	CODE	COUNTRY	CODE	COUNTRY
AX	Åland Islands	ER	Eritrea	LS	Lesotho	SA	Saudi Arabia
AD	Andorra	ES	Spain	LT	Lithuania	SB	Solomon Islands
AE	United Arab Emirates	ET	Ethiopia	LU	Luxembourg	SC	Seychelles
AF	Afghanistan	FI	Finland	LV	Latvia	SE	Sweden
AG	Antigua and Barbuda	FJ	Fiji	LY	Libya	SG	Singapore
AI	Anguilla	FK	Falkland Islands (Malvinas)	MA	Morocco	SH	St. Helena
AL	Albania	FM	Micronesia	MC	Monaco	SI	Slovenia
AM	Armenia	FO	Faroe Islands	MD	Moldova	SJ	Svalbard and Jan Mayen
AN	Netherlands Antilles	FR	France	ME	Montenegro	SK	Slovak Republic
AO	Angola	FX	France, Metropolitan	MG	Madagascar	SL	Sierra Leone
AQ	Antarctica	GA	Gabon	MH	Marshall Islands	SM	San Marino
AR	Argentina	GB	Great Britain (UK)	MK	Macedonia	SN	Senegal
AS	American Samoa	GD	Grenada	ML	Mali	SR	Suriname
AT	Austria	GE	Georgia	MM	Myanmar	ST	Sao Tome and Principe
AU	Australia	GF	French Guiana	MN	Mongolia	SU	USSR (former)
AW	Aruba	GG	Guernsey	MO	Macau	SV	El Salvador
AZ	Azerbaijan	GH	Ghana	MP	Northern Mariana	SZ	Swaziland
BA	Bosnia and	GI	Gibraltar	MQ	Martinique	TC	Turks and Caicos Islands
BB	Barbados	GL	Greenland	MR	Mauritania	TD	Chad
BD	Bangladesh	GM	Gambia	MS	Montserrat	TF	French Southern Territories
BE	Belgium	GN	Guinea	MT	Malta	TG	Togo
BF	Burkina Faso	GP	Guadeloupe	MU	Mauritius	TH	Thailand
BG	Bulgaria	GQ	Equatorial Guinea	MV	Maldives	TJ	Tajikistan
BH	Bahrain	GR	Greece	MW	Malawi	TK	Tokelau
BI	Burundi	GS	S. Georgia and S.	MX	Mexico	TM	Turkmenistan
BJ	Benin	GT	Guatemala	MY	Malaysia	TN	Tunisia
BM	Bermuda	GU	Guam	MZ	Mozambique	TO	Tonga
BN	Brunei Darussalam	GW	Guinea-Bissau	NA	Namibia	TP	East Timor
BO	Bolivia	GY	Guyana	NC	New Caledonia	TR	Turkey
BR	Brazil	HK	Hong Kong	NE	Niger	TT	Trinidad and Tobago
BS	Bahamas	HM	Heard and McDonald	NF	Norfolk Island	TV	Tuvalu
BT	Bhutan	HN	Honduras	NG	Nigeria	TW	Taiwan
BV	Bouvet Island	HR	Croatia (Hrvatska)	NI	Nicaragua	TZ	Tanzania
BW	Botswana	HT	Haiti	NL	Netherlands	UA	Ukraine
BZ	Belize	HU	Hungary	NL	Netherlands	UG	Uganda
CA	Canada	ID	Indonesia	NO	Norway	UM	US Minor Outlying Islands
CC	Cocos (Keeling) Islands	IE	Ireland	NP	Nepal	US	United States
CF	Central African	IL	Israel	NR	Nauru	UY	Uruguay
CH	Switzerland	IM	Isle of Man	NT	Neutral Zone	UZ	Uzbekistan
CI	Cote D'Ivoire (Ivory)	IN	India	NU	Niue	VA	Vatican City State (Holy See)
CK	Cook Islands	IO	British Indian Ocean	NZ	New Zealand	VC	Saint Vincent and the
CL	Chile	IS	Iceland	OM	Oman	VE	Venezuela
CM	Cameroon	IT	Italy	PA	Panama	VG	Virgin Islands (British)
CN	China	JE	Jersey	PE	Peru	VI	Virgin Islands (U.S.)
CO	Colombia	JM	Jamaica	PF	French Polynesia	VN	Viet Nam
CR	Costa Rica	JO	Jordan	PG	Papua New Guinea	VU	Vanuatu
CS	Czechoslovakia (former)	JP	Japan	PH	Philippines	WF	Wallis and Futuna Islands
CV	Cape Verde	KE	Kenya	PK	Pakistan	WS	Samoa
CX	Christmas Island	KG	Kyrgyzstan	PL	Poland	YE	Yemen
CY	Cyprus	KH	Cambodia	PM	St. Pierre and	YT	Mayotte
CZ	Czech Republic	KI	Kiribati	PN	Pitcairn	ZA	South Africa
DE	Germany	KM	Comoros	PR	Puerto Rico	ZM	Zambia
DJ	Djibouti	KN	Saint Kitts and Nevis	PS	Palestinian Territory	COM	US Commercial
DK	Denmark	KR	Korea (South)	PT	Portugal	EDU	US Educational
DM	Dominica	KW	Kuwait	PW	Palau	GOV	US Government
DO	Dominican Republic	KY	Cayman Islands	PY	Paraguay	INT	International
DZ	Algeria	KZ	Kazakhstan	QA	Qatar	MIL	US Military
EC	Ecuador	LA	Laos	RE	Reunion	NET	Network
EE	Estonia	LC	Saint Lucia	RO	Romania	ORG	Non-Profit Organization
EG	Egypt	LI	Liechtenstein	RS	Serbia	ARPA	Old style Arpanet
EH	Western Sahara	LK	Sri Lanka	RU	Russian Federation		
				RW	Rwanda		

5. When you have entered all the required details, press the **Generate** button. The certificate takes several minutes to generate. When the certificate has been generated, you are informed that it has been successfully generated and installed. The web server on the router restarts and you are logged out of the router. Click **OK** to be taken back to the login screen.

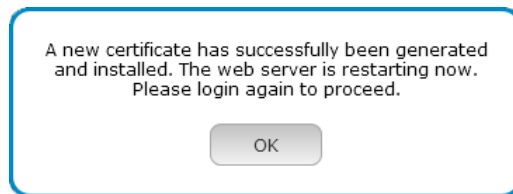

Figure 136 - New certificate successfully generated message

SSH key management

Secure Shell (SSH) is UNIX-based command interface and network protocol used to gain secure access to a remote computer, execute commands on a remote machine or to transfer files between machines. It was designed as a replacement for Telnet and other insecure remote shell protocols which send information, including passwords, as plain text.

SSH uses RSA public key cryptography for both connection and authentication. Two common ways of using SSH are:

- 📶 Use automatically generated public-private key pairs to encrypt the network connection and then use password authentication to log on.
- 📶 Use a manually generated public-private key pair to perform the authentication and allow users or programs to log in without using a password.

SSH server configuration

SSH protocol

Enable password authentication ON OFF

Enable key authentication ON OFF

Host key management

Key type	Date
ssh_host_key	1970-01-01 10:01:02
ssh_host_dsa_key	1970-01-01 10:01:09
ssh_host_rsa_key	1970-01-01 10:01:36
ssh_host_ecdsa_key	1970-01-01 10:01:36

Client key management

Username	Hostname	Key type

Figure 137 - SSH Server Configuration

SSH server configuration

To configure the SSH server settings:

1. Use the SSH Protocol drop down list to select the protocol that you want to use. Protocol 2 is more recent and is considered more secure.
2. Select the types of authentication you want to use by clicking the **Enable password authentication** and **Enable key authentication** toggle keys on or off. Note that you may have both authentication methods on but you may not turn them both off.
3. Click the **Save** button to confirm your settings.

Host key management

SSH keys provide a means of identification using public key cryptography and challenge response authentication. This means that a secure connection can be established without transmitting a password, thereby greatly reducing the threat of someone eavesdropping and guessing the correct credentials.

SSH Keys always come in pairs with one being a public key and the other a private key. The public key may be shared with any server to which you want to connect. When a connection request is made, the server uses the public key to encrypt a challenge (a coded message) to which the correct response must be given. Only the private key can decrypt this challenge and produce the correct response. For this reason, the private key should not be shared with those who do not wish to give authorization.

The Host key management section displays the current public keys on the router and their date and timestamp. These public keys are provided in different formats, including DSA, RSA and ECDSA. Each format has advantages and disadvantages in terms of signature generation speed, validation speed and encryption/decryption speed. There are also compatibility concerns to consider with older clients when using ECDSA, for example.

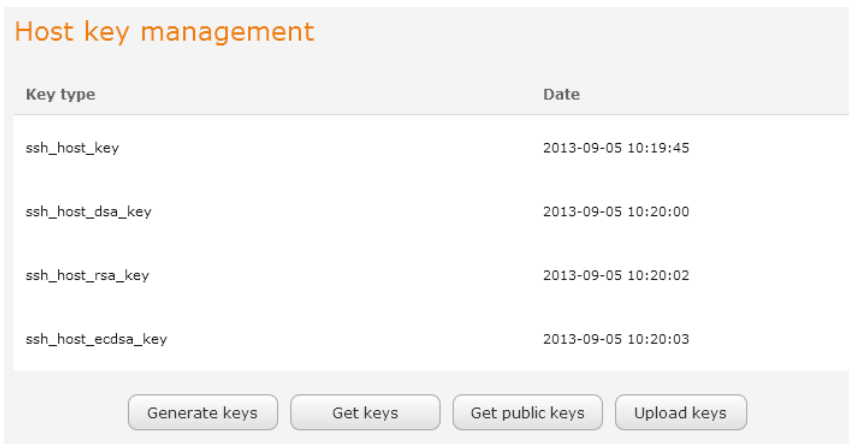

Host key management

Key type	Date
ssh_host_key	2013-09-05 10:19:45
ssh_host_dsa_key	2013-09-05 10:20:00
ssh_host_rsa_key	2013-09-05 10:20:02
ssh_host_ecdsa_key	2013-09-05 10:20:03

Generate keys Get keys Get public keys Upload keys

Generating new keys

The complete set of keys can be re-generated by selecting the **Generate keys** button. This key generation process takes approximately 30 seconds to complete.

Downloading keys

The **Get keys** button allows you to download the complete set of public and private keys while the **Get public keys** button will download only the set of public keys.

Uploading your own key files

You can generate your own SSH keys and upload them to the router. To generate keys on a Linux-based machine, use the following commands:

```
mkdir keys
cd keys
ssh-keygen -t rsa1 -f ssh_host_key -N ""
ssh-keygen -t dsa -f ssh_host_dsa_key -N ""
ssh-keygen -t rsa -f ssh_host_rsa_key -N ""
ssh-keygen -t ecdsa -f ssh_host_ecdsa_key -N ""
zip -e -P "PASSWORDHERE" -j keys.zip *
```

Click the **Upload keys** button then locate the generated keys to upload them to the router.

Client key management

The Client Key Management section is used for uploading the public key file of clients. To upload a client public key, click the **Upload** button, browse to the file and click **Open**.

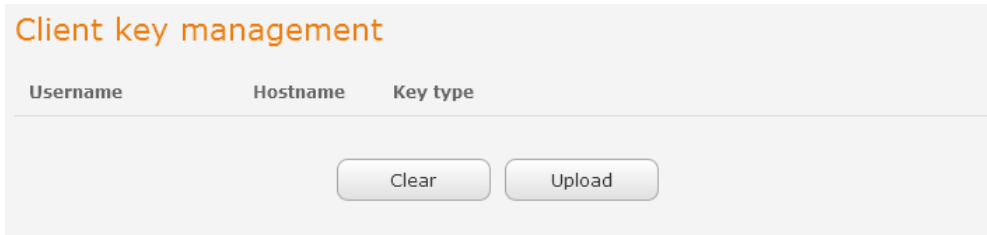

When the file is uploaded, it is examined for validity. If the key file is not a valid public key, it will not be uploaded.

LED operation mode

The 8 front LED indicators may be turned off after a timeout period for aesthetic or power saving reasons. To access the LED Operation Mode page, click the **System** menu, then **Administration** on the left and finally select **LED Operation Mode**.

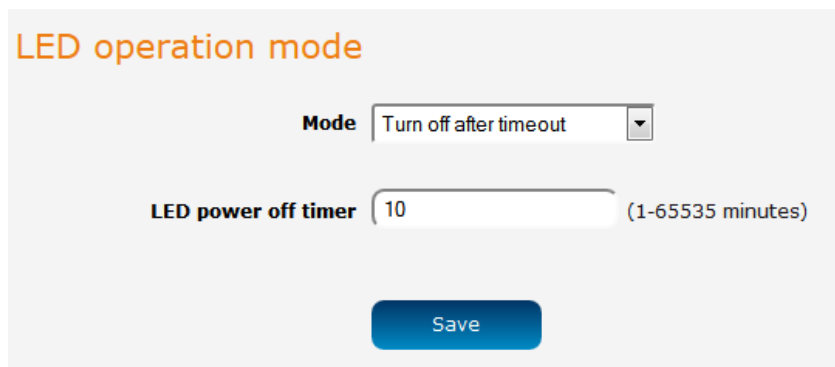

Figure 138 - LED Operation Mode

The **Mode** drop down list sets the operation mode of the LEDs on the front panel of the router. To set the lights to operate at all times, set this to Always on. To set the lights to turn off after a specified period, select **Turn off after timeout**. When configured to turn off after timeout, use the **LED power off timer** field to specify the time in minutes to wait before turning off the LED indicators. The LED Power Off Timer must be an integer between 1 and 65535.

The wait period begins from the time the **Save** button is clicked. When the wait period expires, the LEDs will turn off. If the router is rebooted, the LED power off timer is reset. The router will boot up and wait for the configured time before turning off again.

Watchdogs

To access the Watchdogs page, click the **Services** menu item, then select the **Watchdogs** menu item on the left.

Watchdogs settings

When configured, the watchdog feature transmits controlled ping packets to 1 or 2 user specified IP addresses. Should the watchdog not receive responses to the pings, it will reboot the device in a last resort attempt to restore connectivity.

Please be very careful when considering using this feature in situations where the device is intentionally offline for a particular reason (e.g user configured PDP session disconnect, or the connect on demand feature enabled). This is because the watchdog feature expects to be able to access the internet at all times, and will always eventually reboot the router if access isn't restored by the time the various timers and retries expire.

It is due to the nature of the watchdog being a last resort standalone backup mechanism that it will continue to do its job and reboot the device even when the connect on demand session is idle, or the PDP context is disabled by the user. Therefore, it is recommended to disable this feature if connect on demand is configured, or if the PDP context is intentionally disconnected on occasion.

This feature operates as follows:

- | | |
|----|---|
| A. | After every "Periodic Ping timer" configured interval, the router sends 3 consecutive pings to the "First destination address". |
| B. | If all 3 pings fail the router sends 3 consecutive pings to the "Second destination address". |
| C. | The router then sends 3 consecutive pings to the "First destination address" and 3 consecutive pings to the "Second destination address" every "Periodic Ping accelerated timer" configured interval. |
| D. | If all accelerated pings in step C above fail the number of times configured in "Fail count", the router reboots. |
| E. | If any ping succeeds the router returns to step A and does not reboot. |

Note: The "Periodic Ping timer" should never be set to a value less than 300 seconds- this is to allow the router time to reconnect to the cellular network following a reboot.

To disable the Watchdog, simply set "Fail count" to 0

First destination address	<input type="text"/>	
Second destination address	<input type="text"/>	
Periodic Ping timer	<input type="text" value="0"/>	(0=disable, 300-65535) secs
Periodic Ping accelerated timer	<input type="text" value="0"/>	(0=disable, 60-65535) secs
Fail count	<input type="text" value="0"/>	(0=disable, 1-65535) times
Periodic reboot		
Force reboot every	<input type="text" value="0"/>	(0=disable, 5-65535) mins
Randomize reboot time	<input type="text" value="1 minute"/>	
<input type="button" value="Save"/>		

Figure 139 - Watchdogs Settings

Watchdogs are features which monitor the router for anomalies and restart the router if an anomaly occurs preventing its normal operation. When configured, the watchdogs feature transmits controlled ping packets to 1 or 2 user specified IP addresses to confirm an active connection. If the watchdog does not receive responses to the pings after a specified number of failures, it will reboot the device in a last resort attempt to restore connectivity.

We recommend using caution when implementing this feature in situations where the device is intentionally offline for a particular reason, for example, when Connect-on-demand has been enabled. This is because the watchdog expects to be able to access the internet at all times, and will always eventually reboot the router if access isn't restored by the time the various timers expire and the fail count is reached.

It is due to the nature of the watchdog being a last resort standalone backup mechanism that it will continue to do its job and reboot the device even when the Connect-on-demand session is idle, or the PDP context is disabled by the user. Therefore, we recommended that you disable this feature if Connect-on-demand is configured or if the PDP context is intentionally disconnected on occasion.

The watchdog works as follows:

- a) The router sends 3 consecutive pings to the first destination address at the interval specified in the **Periodic Ping timer** field.
- b) If all 3 pings to the first destination address fail, the router sends 3 consecutive pings to the second destination address at the **Periodic Ping timer** interval.
- c) If all 3 pings to the second destination address fail, the router sends 3 pings to the first destination address using the **Periodic Ping accelerated timer** interval.
- d) If all 3 accelerated pings to the first destination address fail, the router sends 3 pings to the second destination address at the **Periodic Ping accelerated timer** interval.
- e) If all 3 accelerated pings to the second destination address fail, the router registers this as a fail and returns to step C.
- f) When the number of failures reaches the number configured in the **Fail count** field, the router reboots. If any ping succeeds, the router returns to step A and does not reboot.



Note: The **Periodic Ping timer** should not be set to a value of less than 300 seconds to allow the router time to reconnect to the cellular network following a reboot.

To disable the periodic ping reset monitor, set **Fail count** to 0.

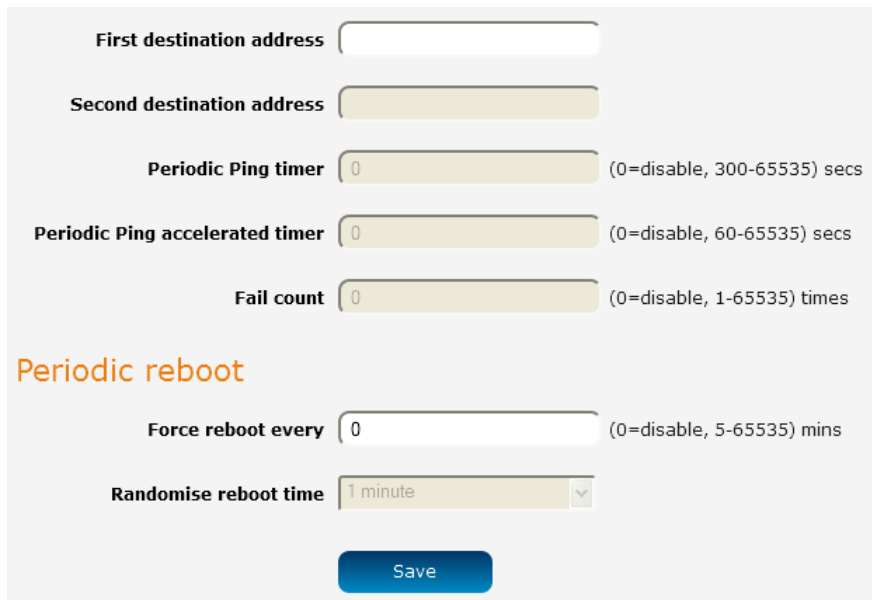

First destination address

Second destination address

Periodic Ping timer (0=disable, 300-65535) secs

Periodic Ping accelerated timer (0=disable, 60-65535) secs

Fail count (0=disable, 1-65535) times

Periodic reboot

Force reboot every (0=disable, 5-65535) mins

Randomise reboot time

Save

Figure 140 – Ping watchdog settings

Configuring Periodic Ping settings

The Periodic Ping settings configure the router to transmit controlled ping packets to 2 specified IP addresses. If the router does not receive responses to the pings, the router will reboot.

To configure the ping watchdog:

1. In the **First destination address** field, enter a website address or IP address to which the router should send the first round of ping requests.
2. In the **Second destination address** field, enter a website address or IP address to which the router should send the second round of ping requests.
3. In the **Periodic Ping timer** field, enter an integer between 300 and 65535 for the number of seconds the router should wait between ping attempts. Setting this to 0 disables the ping watchdog function.
4. In the **Periodic Ping accelerated timer** field, enter an integer between 60 and 65535 for the number of seconds the router should wait between accelerated ping attempts, i.e. pings to the second destination address. Setting this to 0 disables the ping watchdog function.
5. In the **Fail count** field, enter an integer between 1 and 65535 for the number of times an accelerated ping should fail before the router reboots. Setting this to 0 disables the ping watchdog function.

Disabling the Periodic Ping reset function

To disable the Periodic Ping reset function, set **Fail count** to 0.



Note: The traffic generated by the periodic ping feature is usually counted as chargeable data usage. Please keep this in mind when selecting how often to ping.

Configuring a Periodic reboot

The router can be configured to automatically reboot after a period of time specified in minutes. While this is not necessary, it does ensure that in the case of remote installations, the router will reboot if some anomaly occurs.

1. In the **Force reboot every** field, enter the time in minutes between forced reboots. The default value is 0 which disables the Periodic reboot function. The minimum period between reboots is 5 minutes while the maximum value is 65535 minutes.
2. If you have configured a forced reboot time, you can use the **Randomise reboot time** drop down list to select a random reboot timer. Randomising the reboot time is useful for preventing a large number of devices from rebooting simultaneously and flooding the network with connection attempts. When configured, the router waits for the configured **Force reboot every** time and then randomly selects a time that is less than or equal to the **Randomise reboot time** setting. After that randomly selected time has elapsed, the router reboots.
3. Click the **Save** button to save the settings.



Note: The randomise reboot time is not persistent across reboots; each time the router is due to reboot, it randomly selects a time less than or equal to the **Randomise reboot time**.

Power management

The NTC-6200 Series router can be configured to enter or return from a low power ‘sleep’ mode. You can configure this to occur automatically after a timer has expired, by the status of the ignition pin, a combination of timer and ignition pin status or by manually triggering sleep mode.

During the sleep state, the NTC-6200 Series router is effectively powered off. That is, it has no ability to communicate wirelessly or process any information. When in sleep mode, it draws approximately 5mA current at 12V. When sleep state is triggered, the NTC-6200 Series router takes approximately 30 seconds to enter low power mode. When the wake up sequence is initiated, the router takes approximately 2 minutes to return from the sleep state. This is because returning from sleep state involves a full boot up sequence.

Ignition pin

The third pin on the 6-way terminal connector is a dedicated input called “Ignition”. This input is intended for connection to an ignition switch in vehicular applications or where an input to switch the device to a sleep/wake mode is required.

The Ignition input threshold voltage is around 3V. The input responds to a high input state (above 3V). A signal below this level is considered as a low state. If the software is configured to activate in the low state, for example 0V, it must still have the high state above 3V to turn it off.



Note: There is a period of about 10 seconds after sleep state has been triggered where the ignition line cannot be monitored. Please take this into account when designing your ignition power on system.

Low power mode

This device can be configured to enter or return from a low power ‘sleep’ mode. This may occur automatically after a timer has expired and optionally by being sent a signal on the device’s dedicated input line, called the ‘ignition’ input.

During the sleep state, the device is effectively powered off. That is, it has no ability to communicate wirelessly or process any information. It will draw approximately 5mA current at 12V during the sleep state.

After being triggered, it takes approximately 30 seconds to enter the sleep state, and it takes approximately 2 minutes to return from the sleep state (which involves a full device boot up sequence).

Please note there is a period of around 10 seconds after the device is triggered to enter the sleep state where the ignition line cannot be monitored. Please take this into account when designing your ignition power on system.

Low power mode functionality ON OFF

Sleep settings

Sleep mode ▼

Wake settings

Wake mode ▼

Always wake up after (0 - 4294967) seconds

Figure 141 - Low power mode settings

To begin using Low power mode, set the **Low power mode functionality** toggle key to the **ON** position. Extra settings are displayed. These settings, including the enabling or disabling of Low power mode functionality, only take effect when you click the **Save** button.

Sleep settings

Use the **Sleep mode** drop down list to select a condition under which the router should enter the sleep state.

Sleep by manual trigger only

When this mode is selected, the router will only enter the sleep state when the **Trigger sleep mode now** button is pressed. The **Trigger sleep mode now** button is not available unless Low power functionality has been selected and the setting saved.

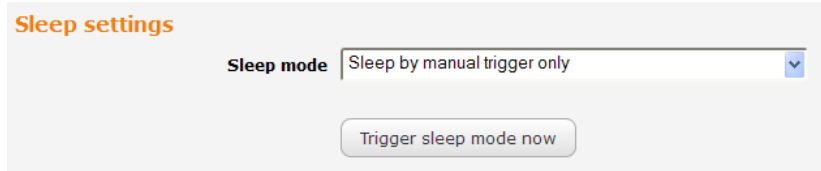

Sleep settings

Sleep mode Sleep by manual trigger only

Trigger sleep mode now

Figure 142 - Sleep by manual trigger only

Sleep after specified duration and ignore ignition pin

When this mode is selected, the router goes to sleep after the specified time period regardless of the state of the ignition pin.

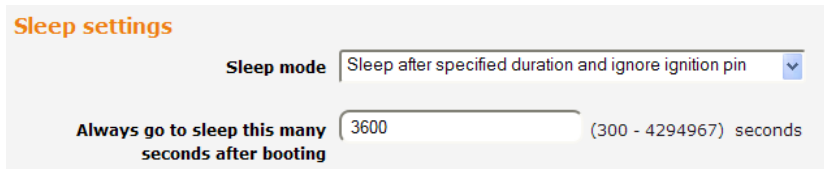

Sleep settings

Sleep mode Sleep after specified duration and ignore ignition pin

Always go to sleep this many seconds after booting 3600 (300 - 4294967) seconds

Figure 143 - Sleep after specified duration and ignore ignition pin

Enter the time in seconds to wait before entering sleep state in the **Always go to sleep this many seconds after booting** field. A setting of 0 means that the router will never enter sleep state.

Sleep triggered by ignition pin status

This mode sets the router to enter sleep state when the signal on the ignition pin reaches the specified value.

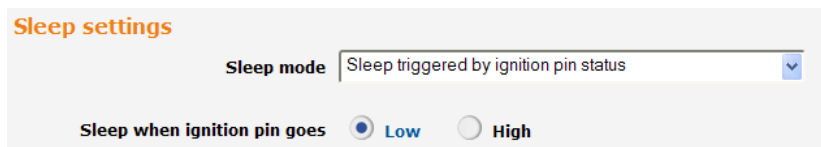

Sleep settings

Sleep mode Sleep triggered by ignition pin status

Sleep when ignition pin goes Low High

Figure 144 - Sleep triggered by ignition pin status

Use the **Sleep when ignition pin goes** setting to select **Low** or **High**. By default, this is set to **Low**.

Sleep after specified duration or triggered by ignition pin

This option sets the router to go to the sleep state on one of two conditions, depending on which condition is reached first. These conditions are based on the state of the ignition pin and a timer. For example, based on the configuration in the screenshot below, the router will go to sleep state when the ignition pin goes low or after 3600 seconds (1 hour), depending on which condition occurs first.

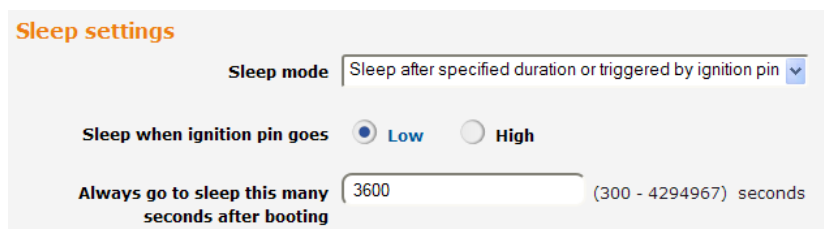

Sleep settings

Sleep mode Sleep after specified duration or triggered by ignition pin

Sleep when ignition pin goes Low High

Always go to sleep this many seconds after booting 3600 (300 - 4294967) seconds

Figure 145 - Sleep after specified duration or triggered by ignition pin

Wake settings

Use the **Wake mode** drop down list to select a condition under which the router should return from the sleep state.

Only wake after specified duration and ignore ignition pin

When this mode is selected, the router wakes up after the specified time period regardless of the state of the ignition pin.

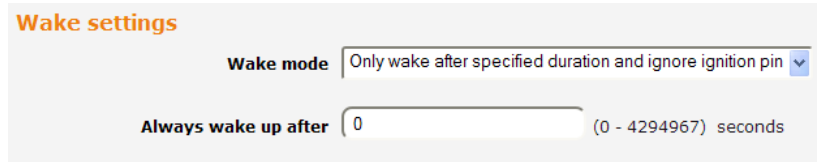

The screenshot shows the 'Wake settings' section with the 'Wake mode' dropdown set to 'Only wake after specified duration and ignore ignition pin'. Below it, the 'Always wake up after' field is set to '0' seconds, with a range of '(0 - 4294967) seconds'.

Figure 146 - Only wake after specified duration and ignore ignition pin

Enter the time in seconds to wait before returning from sleep state in the **Always wake up after** field. A setting of 0 means that the router will automatically wake from sleep state immediately.

Wake triggered by ignition pin status

This mode sets the router to wake up when the signal on the ignition pin reaches the specified value.

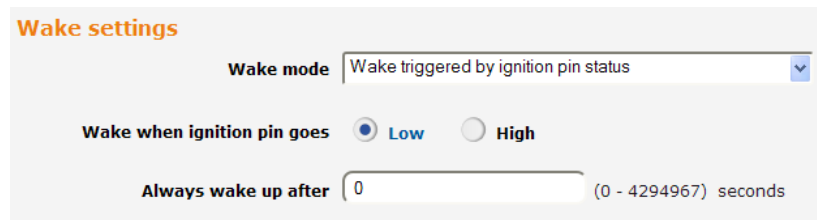

The screenshot shows the 'Wake settings' section with the 'Wake mode' dropdown set to 'Wake triggered by ignition pin status'. Below it, the 'Wake when ignition pin goes' section has two radio buttons: 'Low' (selected) and 'High'. The 'Always wake up after' field is set to '0' seconds, with a range of '(0 - 4294967) seconds'.

Figure 147 - Wake when triggered by ignition pin status

Use the **Sleep when ignition pin goes** setting to select **Low** or **High**. By default, this is set to **Low**.

Advanced wake settings

The advanced wake settings screen gives you finer control over the events causing the router to wake up. In advanced wake mode, you can configure the router to monitor for up to 2 changes in the status of the ignition pin along with how long those status changes should last for to trigger a single wake up event. When selected, Event 1 and Event 2 must happen consecutively in that order to satisfy each condition.



Note: If you do not wish to specify 2 events you should select to skip Event 1, in which case the router will only monitor Event 2 to trigger a wake up.

There is also a provision to reboot the router after a specified period of time, regardless of whether the conditions of Events 1 and/or 2 are met. This can be viewed as a fall back option in the case that those Events are missed.

Wake settings

Wake mode

Advanced wake settings

In order to wake from sleep, you may choose to create up to 2 ignition pin events which must occur in a row in order to wake. Please choose the two required events below. If you wish to only require a single ignition pin event to occur, then please select Skip for Event 1, and configure Event 2 as desired.

For 'Stable time' fields, choose how long the ignition value must be stable for this Event (in 10ms increments).
 Note: 0 is a valid value, meaning instantaneous, 1 means 10ms etc.

Event 1

Required ignition line value for Event 1 Low High Skip

Stable time (0 - 65535) x10ms

Event 2

Required ignition line value for Event 2 Low High Skip

Stable time (0 - 65535) x10ms

Always wake up after (0 - 4294967) seconds

Figure 148 - Advanced wake up configuration

To configure advanced wake settings:

1. Set **Wake mode** to **Advanced (configure below)**.
2. Under **Event 1**, select whether you want the ignition pin value to be **Low** or **High**. If you want to skip this event, select the **Skip** option.
3. In the Event 1 **Stable time** field, enter the length of time expressed in milliseconds that the value of the ignition line should remain low or high. For example, to specify 10 seconds, enter a value of 1000.
4. Under **Event 2**, select whether you want the ignition pin value to be **Low** or **High**. If you want to skip this event, select the **Skip** option.
5. In the Event 2 **Stable time** field, enter the length of time expressed in milliseconds that the value of the ignition line should remain low or high.
6. In the **Always wake up after** field, enter the time in seconds after which the router should wake up, regardless of whether Event 1 or 2 has occurred.

When in low power mode and Advanced wake mode is configured, the router waits for Event 1 to occur, then it monitors for Event 2. If Event 2 occurs before Event 1, it will not trigger the condition for either event to have occurred. If Event 1 occurs and then Events 2 occurs, the router wakes up. Alternatively, if neither or only one of the events occurs, the router waits for the time specified in the **Always wake up after** field and then wakes up when that time has been reached.

Reboot

The reboot option in the System section performs a soft reboot of the router. This can be useful if you have made configuration changes you want to implement.

To reboot the router:

1. Click the **System** menu item from the top menu bar.
2. Click the **Reboot** button from the menu on the left side of the screen.

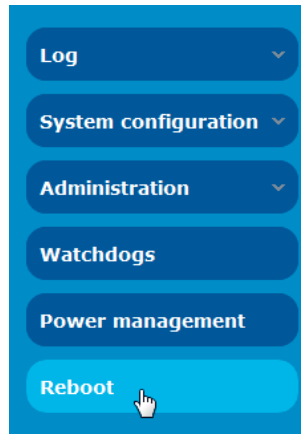

Figure 149 - Reboot menu option

3. The router displays a warning that you are about to perform a reboot. If you wish to proceed, click the **Reboot** button then click **OK** on the confirmation window which appears.

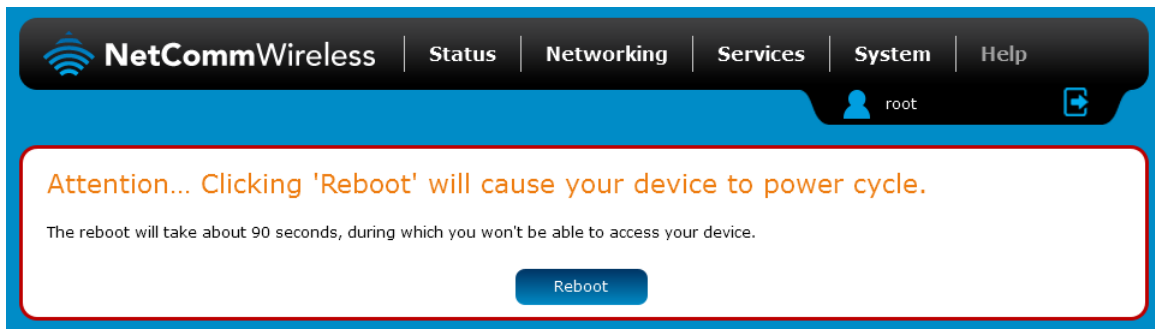



Figure 150 - Reboot confirmation



Note: It can take up to 2 minutes for the router to reboot.

Logging out

To log out of the router, click the  icon at the top right corner of the web user interface.

Appendix A: Tables

Table 1 - Document Revision History	2
Table 2 - Device Dimensions.....	9
Table 3 - LED Indicators	10
Table 4 - Signal strength LED descriptions.....	11
Table 5 - Ethernet port LED indicators description.....	11
Table 6 – Interfaces - NTC-6200-02 and NTC-6200-12 models	12
Table 7 – Interfaces NTC-6200-03 and NTC-6200-13 models	13
Table 8 - Locking power block pin outs.....	18
Table 9 - Locking power block pin outs.....	18
Table 10 - Average power consumption figures	19
Table 11 - Management account login details – Root manager	20
Table 12 - Management account login details – Admin manager.....	20
Table 13 - Status page item details.....	23
Table 14 - Data connection item details	25
Table 15 - Connect on demand - Connect and disconnect timers descriptions	31
Table 16 - Ethernet group configuration items	43
Table 17 - Ethernet WAN configuration options.....	44
Table 18 - Failover configuration - Hardware link monitoring.....	45
Table 19 - Current MAC / IP / Port filtering rules in effect.....	58
Table 20 - IPSec Configuration Items	61
Table 21 – TCP server endpoint options.....	75
Table 22 – TCP client endpoint options.....	76
Table 23 - Modem emulator endpoint options.....	79
Table 24 - PPP server endpoint options	80
Table 25 - IP modem endpoint configuration.....	80
Table 26 – IP modem endpoint options.....	81
Table 27 – CSD endpoint options	81
Table 28 – TCP connect-on-demand endpoint options	82
Table 29 - Data stream applications.....	85
Table 30 - Modem emulator options	87
Table 31 – OMA Lightweight M2M configuration options.....	94
Table 32 - Mobile Station Based Assisted GPS configuration options.....	96
Table 33 - Odometer configuration options	97
Table 34 - IO configuration options	98
Table 35 - IO pin modes	99
Table 36 - Event notification configuration options.....	101
Table 37 - Event notification – event types	101
Table 38 - Email client settings.....	106
Table 39 - SMS Setup Settings.....	108
Table 40 - Inbox/Outbox icons.....	110
Table 41 - SMS Diagnostic Command Syntax.....	115
Table 42 - List of basic SMS diagnostic commands	117
Table 43 - List of get/set commands.....	118
Table 44 - List of basic SMS diagnostics RDB variables	119
Table 45 - Network types returned by get plmns can SMS command	120
Table 46 - Operator status codes returned by get plmns can SMS command	120
Table 47 - SMS diagnostics example commands.....	122
Table 48 - System log detail levels	126
Table 49 - Administration configuration options.....	132
Table 50 - LAN Management Default Settings.....	149
Table 51 - Web Interface Default Settings	149
Table 52 - Telnet Access	149
Table 53 - RJ-45 connector pin outs.....	156
Table 54 - RS-232 Wiring	157

Table 55 - RS-485 Half Duplex Wiring	157
Table 56 - RS-485 (RS-422) Full Duplex Wiring	157

Appendix B: Default Settings

The following tables list the default settings for the NTC-6200 Series router.

LAN (MANAGEMENT)	
Static IP Address:	192.168.1.1
Subnet Mask:	255.255.255.0
Default Gateway:	192.168.1.1

Table 50 - LAN Management Default Settings

ADMIN MANAGER ACCOUNT		ROOT MANAGER ACCOUNT	
Username:	admin	Username:	root
Password:	admin	Password:	admin

Table 51 - Web Interface Default Settings





Note: The admin manager account allows you to manage all settings of the router except functions such as firmware upgrade, device configuration backup and restore and reset to factory default settings, which are privileged only to the root manager account.

NTC-6200 SERIES ROUTER TELNET ACCESS	
Username:	root
Password:	admin



Table 52 - Telnet Access

Restoring factory default settings

Restoring factory defaults will reset the NTC-6200 Series router to its factory default configuration. You may encounter a situation where you need to restore the factory defaults on your NTC-6200 Series router such as:

-  You have lost your username and password and are unable to login to the web configuration page;
-  You are asked to perform a factory reset by support staff.

There are two methods you can use to restore factory default settings on your NTC-6200 Series router:

-  Using the web-based user interface
-  Using the reset button on the interface panel of the router

Using the web-based user interface

To restore your router to its factory default settings, please follow these steps:

1. Open a browser window and navigate to the IP address of the router (default address is <http://192.168.1.1>). Login to the router using **root** as the User Name and **admin** as the password.
2. Click the **System** item from the top menu bar, then **System configuration** on the left menu and then click **Settings backup and restore**.
3. Under the **Restore factory defaults** section, click the **Restore defaults** button. The router asks you to confirm that you wish to restore factory defaults. Click **OK** to continue. The router sets all settings to default. Click **OK** again to reboot the router.
4. When the Power light returns to a steady red, the reset is complete. The default settings are now restored.

Using the reset button on the interface panel of the router

Use a pen to depress the Reset button on the device for 15-20 seconds. The router will restore the factory default settings and reboot.

When you have reset your NTC-6200 Series router to its default settings you will be able to access the device's configuration web interface using <http://192.168.1.1> with username **admin** or **root** and password **admin**.

Appendix C: Recovery mode

The NTC-6200 Series Router features two independent operating systems, each with its own file systems. These two systems are referred to as 'Main' and 'Recovery'. It is always possible to use one in order to restore the other in the event that one system becomes damaged or corrupted (such as during a firmware upgrade failure). The recovery console provides limited functionality and is typically used to restore the main firmware image in the case of a problem.

Accessing recovery mode

Both systems have web interfaces that can be used to manipulate the other inactive system. The NTC-6200 Series Router starts up by default in the Main system mode, however the router may be triggered to start in recovery mode if desired.

To start the router in recovery mode:

1. Press and hold the physical reset button on the interface panel of the router for 5 to 15 seconds. When the LEDs on the front panel change to amber and countdown in a sequence, release the reset button. The router then boots into recovery mode.
2. In your browser, navigate to <http://192.168.1.1>. The router's recovery mode is hardcoded to use this address regardless of the IP address that was configured in the main system. The router's recovery console is displayed.

NetComm Cellular Router Recovery Console

Status	Log	Application Installer	Settings	Reboot
Status				
System Information				
System Up time	00:01:19			
Router Version	Hardware: 1.0 Software: XXXXXXXX			
Serial Number	164199131700017			
Trigger	button			
LAN				
IP	192.168.1.1 / 255.255.255.0			
MAC Address	00:60:64:B2:D4:22			
Ethernet Port Status				
LAN: 	Up / 100.0 Mbps / FDX			

Figure 151 - Recovery console

Status

The status page provides basic information such as the system up time, hardware and software router versions, the router's serial number, the method used to trigger the recovery mode, the IP and MAC address of the router and the status of the Ethernet port.

NetComm Cellular Router Recovery Console

Status	Log	Application Installer	Settings	Reboot
Status				
System Information				
System Up time	00:01:19			
Router Version	Hardware:1.0 Software: XXXXXXXX			
Serial Number	164199131700017			
Trigger	button			
LAN				
IP	192.168.1.1 / 255.255.255.0			
MAC Address	00:60:64:B2:D4:22			
Ethernet Port Status				
LAN: 	Up / 100.0 Mbps / FDX			

Figure 152 - Recovery mode - Status

Log

The log page displays the system log which is useful in troubleshooting problems which may have led to the router booting up in recovery mode. The only functionality provided here is the ability to clear the system log, filter by log level and downloading of the log file.



Status	Log	Application Installer	Settings	Reboot
Log File Display Level Debug  Page 1 of 16  Clear Log File				
Date & Time	Machine	Level	Process	Message
Dec 19 08:31:01	ntc_6200	daemon.warn	dnsmasq-dhcp[373]	Ignoring domain corp.netcomm.com.au for DHCP host name pdg26
Dec 19 08:31:01	ntc_6200	daemon.info	dnsmasq-dhcp[373]	DHCPACK(eth0) 192.168.1.148 00:21:9b:1a:89:ee pdg26
Dec 19 08:31:01	ntc_6200	daemon.info	dnsmasq-dhcp[373]	DHCPREQUEST(eth0) 192.168.1.148 00:21:9b:1a:89:ee
Dec 19 08:31:01	ntc_6200	daemon.info	dnsmasq-dhcp[373]	DHCPPOFFER(eth0) 192.168.1.148 00:21:9b:1a:89:ee
Dec 19 08:31:01	ntc_6200	daemon.warn	dnsmasq[373]	overflow: 5 log entries lost
Dec 19 08:30:19	ntc_6200	daemon.info	dnsmasq[373]	started, version 2.57 cachesize 150
Dec 19 08:31:00	ntc_6200	user.info	dispd[429]	[disp] boot period time-out - sec=40 sec
Dec 19 08:30:20	ntc_6200	user.info	dispd[429]	router normal LED mode activated
Dec 19 08:30:20	ntc_6200	user.info	dispd[429]	force to redraw all LEDs
Dec 19 08:30:20	ntc_6200	user.info	dispd[429]	[led-off] resetting dim timer (sec) - current timer=0
Dec 19 08:30:20	ntc_6200	user.info	dispd[429]	[led-off] set dim timer - timer=0 sec
Dec 19 08:30:20	ntc_6200	user.err	dispd[429]	set priority (prior=-20)
Dec 19 08:30:20	ntc_6200	user.info	dispd[429]	syslog LOG_INFO
Dec 19 08:30:20	ntc_6200	user.err	dispd[429]	syslog LOG_ERR
Dec 19 08:30:20	ntc_6200	user.err	dispd[429]	=====
Dec 19 08:30:20	ntc_6200	user.err	dispd[429]	loglevel check
Dec 19 08:30:20	ntc_6200	user.err	dispd[429]	=====
Dec 19 08:30:20	ntc_6200	user.info	kernel	[10.190000] IPv6: ADDRCONF(NETDEV_CHANGE): eth0: link becomes ready
Dec 19 08:30:20	ntc_6200	user.info	kernel	[10.190000] libphy: 800f0000.etherne:00 - Link is Up - 100/Full
Dec 19 08:30:20	ntc_6200	user.info	kernel	[8.190000] [T42]joonfig_aneq:134: FIXME: autoneg restart currently broken
Dec 19 08:30:20	ntc_6200	kernel.debug	kernel	[7.610000] gpio_request: gpio-125 (odoc_gpio) status -16
Dec 19 08:30:20	ntc_6200	user.info	kernel	[7.200000] IPv6: ADDRCONF(NETDEV_UP): eth0: link is not ready
Dec 19 08:30:20	ntc_6200	user.info	kernel	[7.190000] eth0: Freescale FEC PHY driver [SMSC LAN8710/LAN8720] (mii_bus:phy_addr=800f0000.etherne:00, irq=193)
Download Log File				

Figure 153 - Recovery mode - Log

Application Installer

The Application installer is designed to upload and install main firmware images, upload recovery firmware images, custom applications and HTTPS certificates. Use the **Browse** button to select a file to be uploaded to the router. When it has been selected, press the **Upload** button. The file is sent to the router and when the transfer is complete, the file appears in the Uploaded files list. From the Uploaded files list, you are able to either **Install** or **Delete** a file.

Status	Log	Application Installer	Settings	Reboot
--------	-----	-----------------------	----------	--------

[Recovery Console > Upload](#)

Upload:

File No file selected.

Uploaded Files:

Free Space: 92.3M

File Name	Date	Size	Action
ntc_6200_vX.XX.XX.X.cdi	Dec 18 2013	31.0M	Install Delete
ntc_6200_vX.XX.XX.X_r.cdi	Dec 18 2013	12.6M	Install Delete

Figure 154 - Recovery mode - Application Installer

Settings

The settings page provides the option of restoring the router to factory default settings. Click the **Restore** button to set the router back to the original factory settings.

Status	Log	Application Installer	Settings	Reboot
--------	-----	-----------------------	----------	--------

[Settings](#)

RESTORE FACTORY DEFAULTS:

Figure 155 - Recovery mode - Settings

Reboot

The reboot page allows you to reboot the router when you have finished using recovery mode. When rebooting the router from recovery mode, the router boots into the main firmware image unless there is some fault preventing it from doing so, in which case the recovery console will be loaded.

Click the **Reboot** button to reboot the router to the main firmware image.

Status	Log	Application Installer	Settings	Reboot
--------	-----	-----------------------	----------	--------

[Reboot](#)

To perform the reboot, click on the "Reboot" button below. You will be asked to confirm your decision.

Figure 156 - Recovery mode - Reboot

Appendix D: HTTPS - Uploading a self-signed certificate

If you have your own self-signed certificate or one purchased elsewhere and signed by a Certificate Authority, you can upload it to the NTC-6200 Series router using the [Upload](#) page.



Note: Your key and certificate files must be named **server.key** and **server.crt** respectively otherwise they will not work.

To upload your certificate:

1. Click on the **System** item from the top menu bar. From the side menu bar, select **System Configuration** and then **Upload**. The file upload screen is displayed.

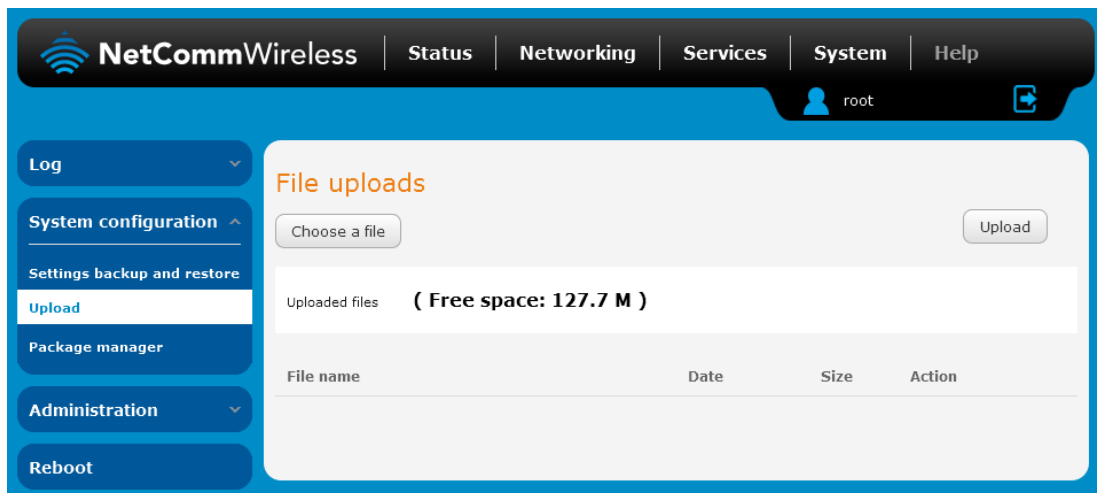

Figure 157 - Upload page

2. Click the **Choose a File** button and locate your server certificate file and click **Open**.

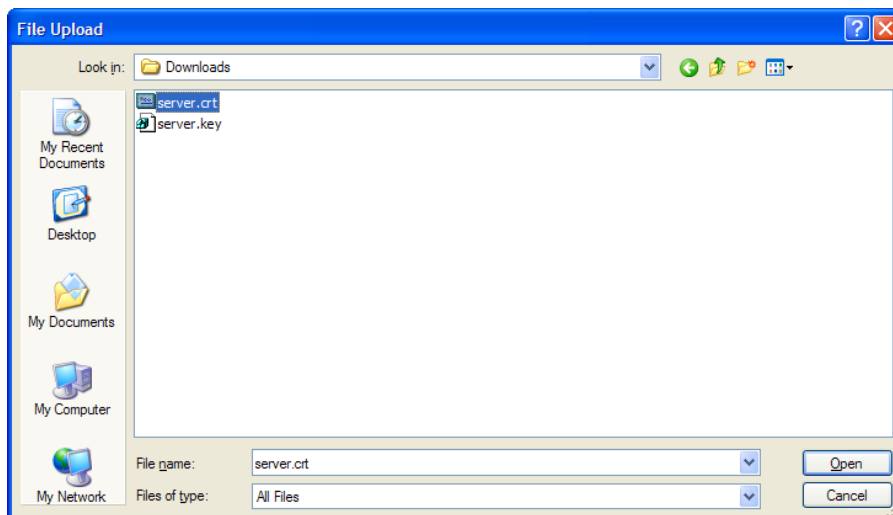

Figure 158 - Browse for server.crt

- Click the **Upload** button to begin uploading it to the router. The file appears in the list of files stored on the router.

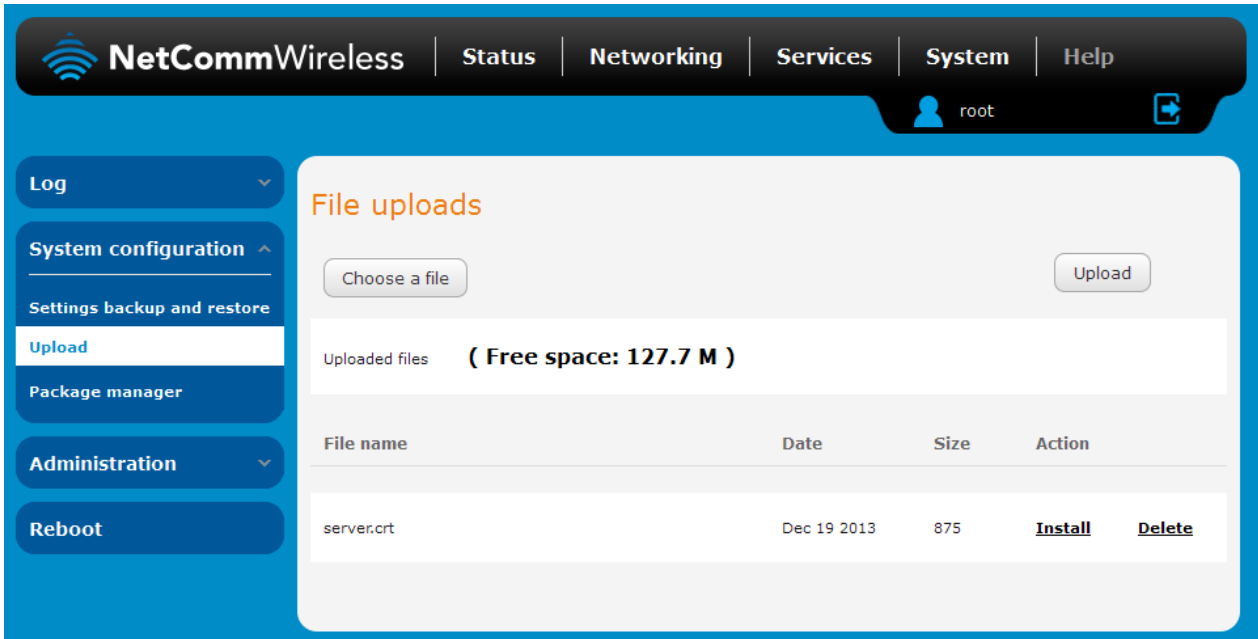

Figure 159 - Server certificate file uploaded

- Repeat steps 2 and 3 for the server key file.
- Click the **Install** link next to the server.crt file then click **OK** on the prompt that is displayed. The certificate file is installed. Repeat this for the key file. When each file is installed it is removed from the list of stored files.

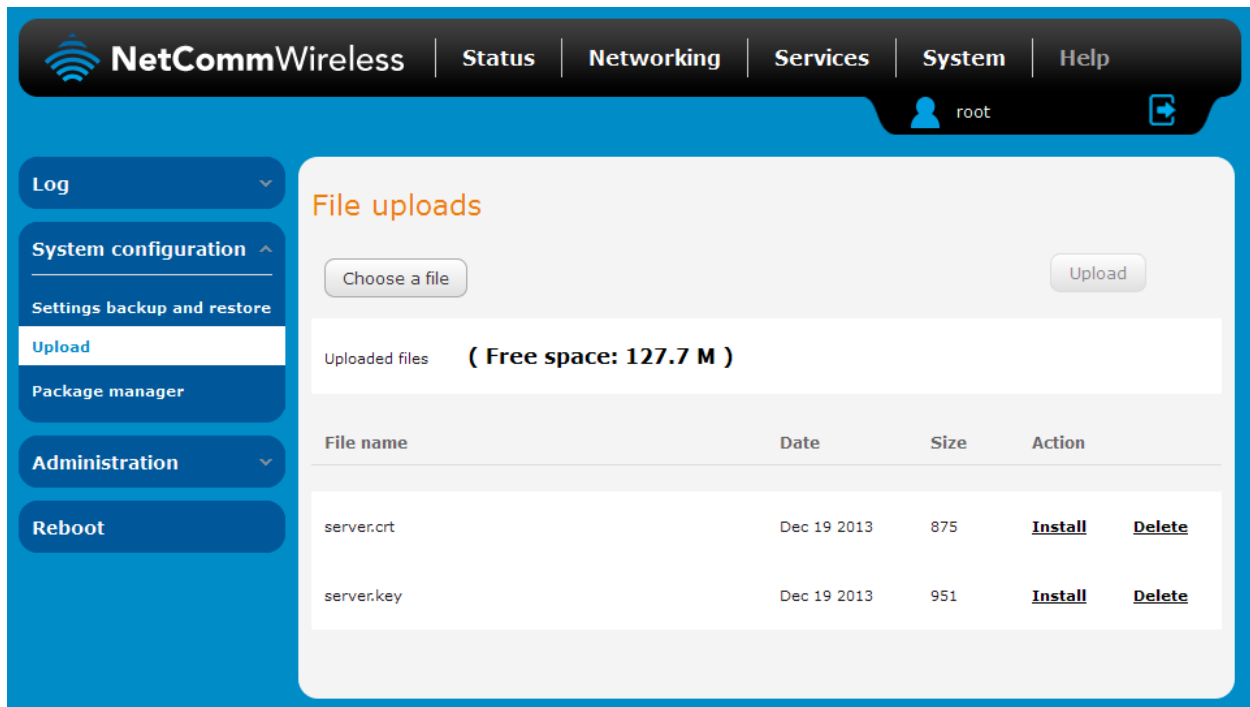

Figure 160 - Installing the server.crt file

Appendix E: RJ-45 connector

The RJ-45 connector provides an interface for a data connection and for device input power using the pin layout shown below.



Pin: 8 1

Figure 161 -The RJ-45 connector

PIN	COLOUR	SIGNAL (802.3AF MODE A)	SIGNAL (802.3AF MODE B)
1	White/Orange stripe	Rx +	Rx + DC +
2	Orange Solid	Rx -	Rx - DC +
3	White/Green stripe	Tx +	Tx + DC -
4	Blue solid	DC +	unused
5	White/Blue stripe	DC +	unused
6	Green solid	Tx -	Tx - DC -
7	White/Brown stripe	DC -	unused
8	Brown solid	DC -	unused

Table 53 - RJ-45 connector pin outs

Appendix F: Serial port wiring

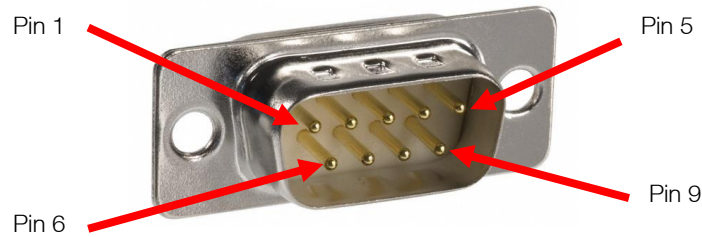

Figure 162 - DE9 Male connector (Pin side view)

The NTC-6200 Series router has a serial interface and acts as the data communications equipment (DCE). The wiring tables below indicate the DCE and DTE devices as well as the signal direction. Shielding cable can optionally be soldered to the chassis and connected to ground.

DTE DEVICE (COMPUTER)			SIGNAL DIRECTION	DCE DEVICE (NTC-6200 ROUTER)		
PIN	NAME	DESCRIPTION		DESCRIPTION	NAME	PIN
1	DCD	Data carrier detect	←	Data carrier detect	DCD	1
2	RXD	Receive Data	←	Receive Data	RXD	2
3	TXD	Transmit Data	→	Transmit Data	TXD	3
4	DTR	Data Terminal Ready	→	Data Terminal Ready	DTR	4
5	GND	Ground	█	Ground	GND	5
6	DSR	Data Set Ready	←	Data Set Ready	DSR	6
7	RTS	Request to Send	→	Request to Send	RTS	7
8	CTS	Clear to Send	←	Clear to Send	CTS	8
9	RI	Ring Indicator	←	Ring Indicator	RI	9
-	FGND	Shield (Soldered to D9 metal shield)	█	Shield (Soldered to D9 metal shield)	FGND	-

Table 54 - RS-232 Wiring

RS-485 HALF DUPLEX WIRING			
PIN	SIGNAL	NAME	DESCRIPTION
1	-	A	Differential pair A
2	+	B	Differential pair B
5		GND	Ground

Table 55 - RS-485 Half Duplex Wiring

RS-485 (RS-422) FULL DUPLEX WIRING			
PIN	SIGNAL	NAME	DESCRIPTION
1	-	RXA	Receive (Differential pair A)
2	+	RXB	Receive (Differential pair B)
3	+	TXB	Transmit (Differential pair B)
4	-	TXA	Transmit (Differential pair A)
5		GND	Ground

Table 56 - RS-485 (RS-422) Full Duplex Wiring

Appendix G: Inputs/Outputs

Overview

The NTC-6200-02 and NTC-6200-12 are equipped with a 6-way terminal block connector providing 3 identical multipurpose inputs and outputs as well as a dedicated ignition input. These inputs and outputs may be independently configured for various functions, including:

- NAMUR (EN 60947-5-6 / IEC 60947-5-6) compatible sensor input
- Proximity sensor input for use with contact closure (open/closed) type of sensors (PIR sensors, door/window sensors for security applications) with the input tamper detection possible (four states detected: open, closed, short and break) by the use of external resistors
- Analogue 0V to 30V input
- Digital input (the I/O voltage measured by the Analogue input and the software making a decision about the input state) with the threshold levels configurable in software
- Open collector output.

Hardware Interface

The interface of the 3 multipurpose inputs/outputs are based on the circuit diagram below

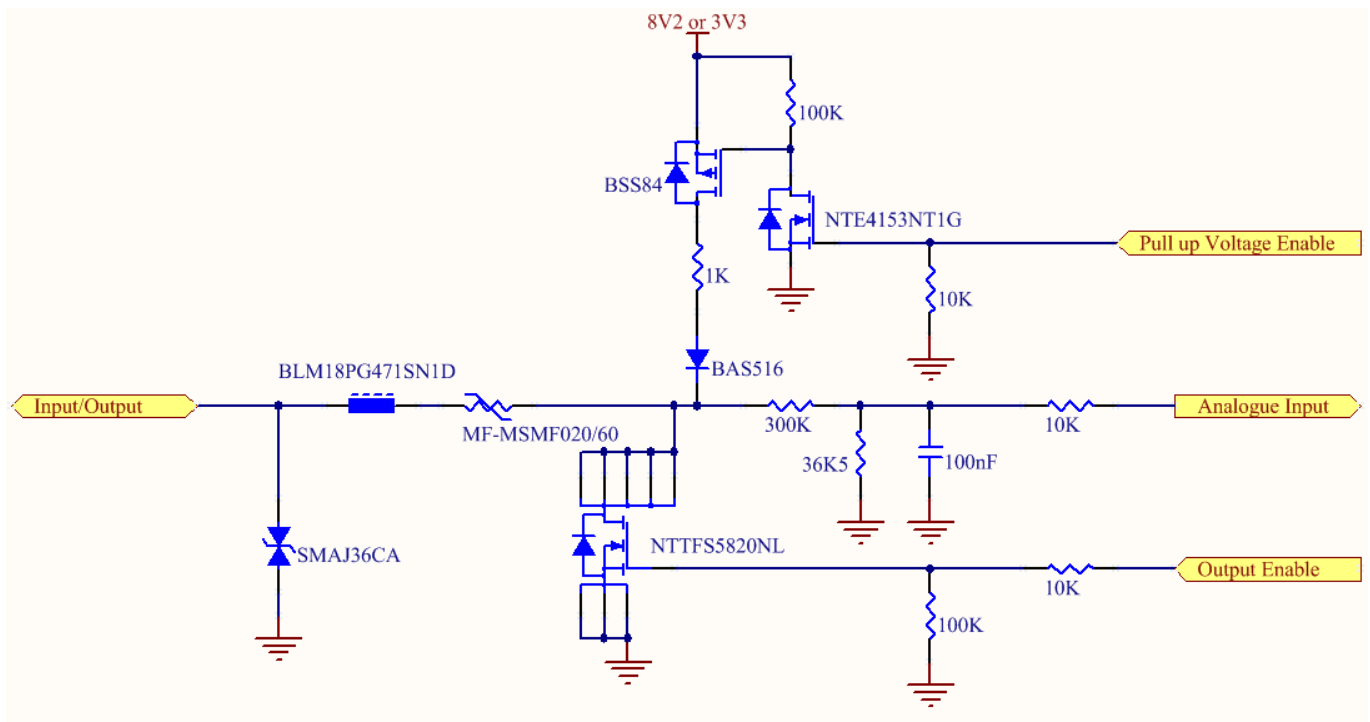

The **Input/Output** label is the physical connection to the outside world. There are protection devices and resistor dividers to condition the signal prior to it going into the processor. The three labels to the right are the interface to the processor. **Output Enable** activates the Transistor which provides an open collector (ground) output and can sink 200mA at 23°C. It is protected by a resettable fuse and transient protection diode. If used with the pull up resistor, which can be activated by the **Pull up Voltage Enable** pin, then you can have a High or Low output rather than open drain. The resistor can be pulled up to 3V3 for Cmos compatible output or 8.2V by software. The **Analogue Input** pin can read values from 0V to 30V. It is divided by a resistor network to read appropriate levels in the processor. Depending on the sensor type used, the pull up resistor can be switched on or off. If using the NAMUR sensor configuration the pull up will be activated to 8V2 by default.

Wiring Examples

The following examples are shown as a guide as to what can be achieved by the I/O features. It is up to the system integrator to have enough knowledge about the interface to be able to achieve the required results.



Note: NetComm Wireless does not offer any further advice on the external wiring requirements or wiring to particular sensors, and will not be responsible for any damage to the unit or any other device used in conjunction with it. Using outputs to control high voltage equipment can be dangerous. The integrator must be a qualified electrician if dealing with mains voltages controlled by this unit.

Open Collector Output driving a relay

Any output can be configured to control a relay. This is an example where the transistor will supply the ground terminal of the solenoid. External voltage is supplied to the other side of the solenoid.

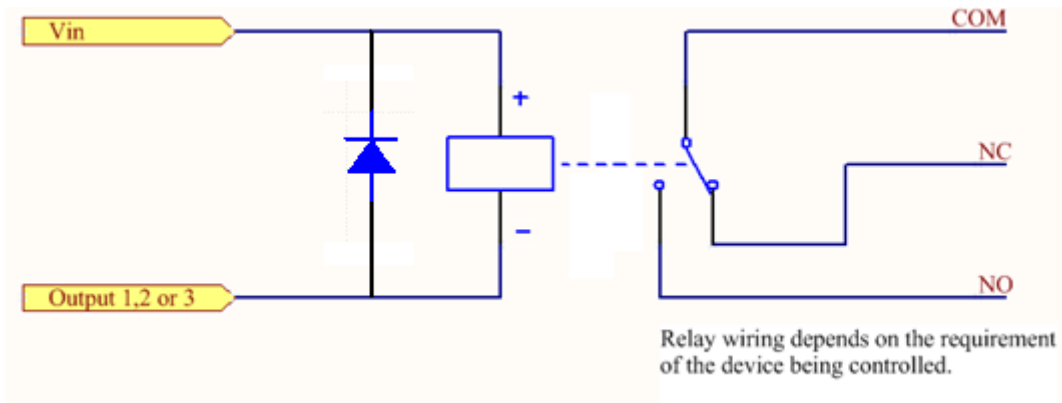

Logic level Output

An output can be used with the pull up resistor to provide a logic level output which would be suitable to control an external digital device.

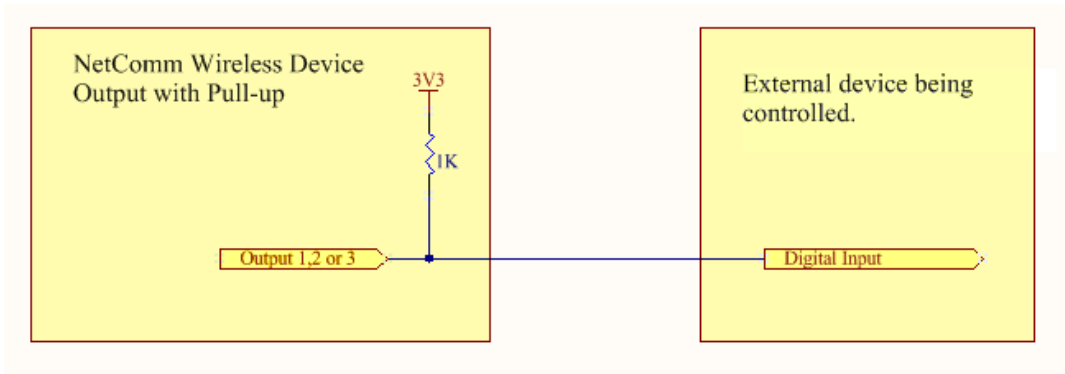

LED Output

An LED can be controlled by simply providing an open collector ground to an externally powered LED Resistor value and Voltage will need to suit the LED type used. Alternatively an LED can be powered using 8V2 via 1K resistor. The suitability of the LED will need to be investigated.

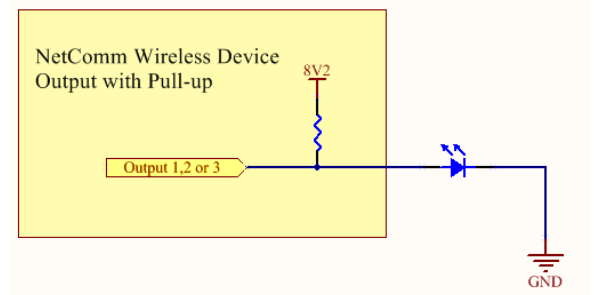
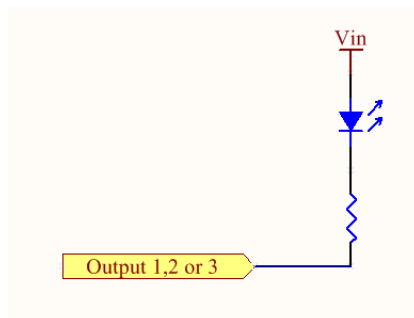

Digital inputs

There are several ways to connect a digital input. A digital input can be anything from a simple switch to a digital waveform or pulses. The unit will read the voltage in as an analogue input and the software will decode it in a certain way depending on your configuration.

Below is a contact closure type input, which is detecting an Earth. Pull up is activated for this to work.

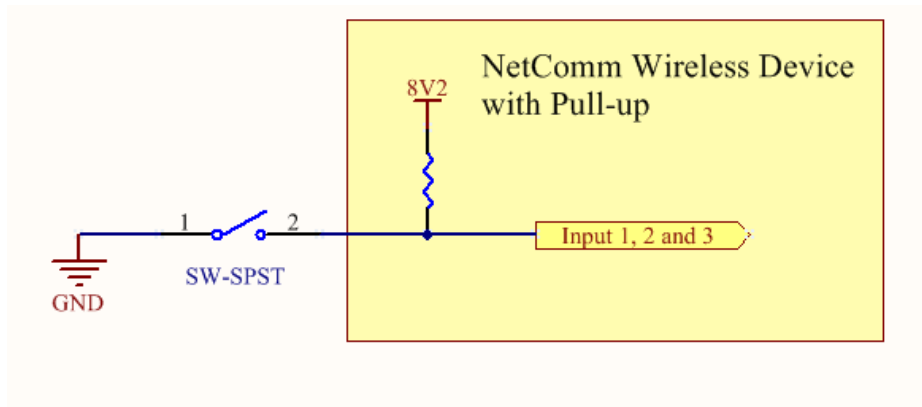

The following input detects an input going high. The turn on/off threshold can be set in the software.

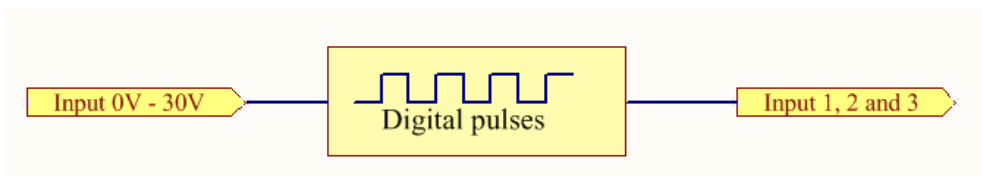
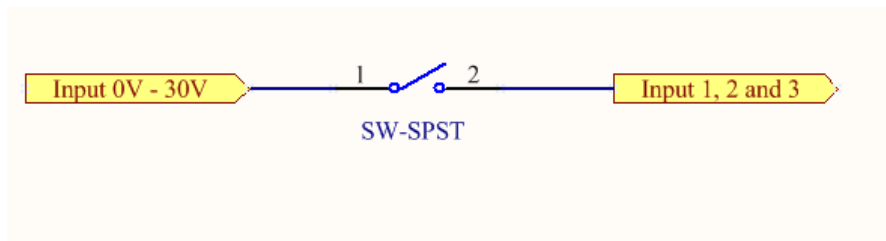

NAMUR Sensor

A NAMUR sensor is a range of sensors which conform to the EN 60947-5-6 / IEC 60947-5-6 standards. They basically have two states which are reflected by the amount of current running through a sense resistor.

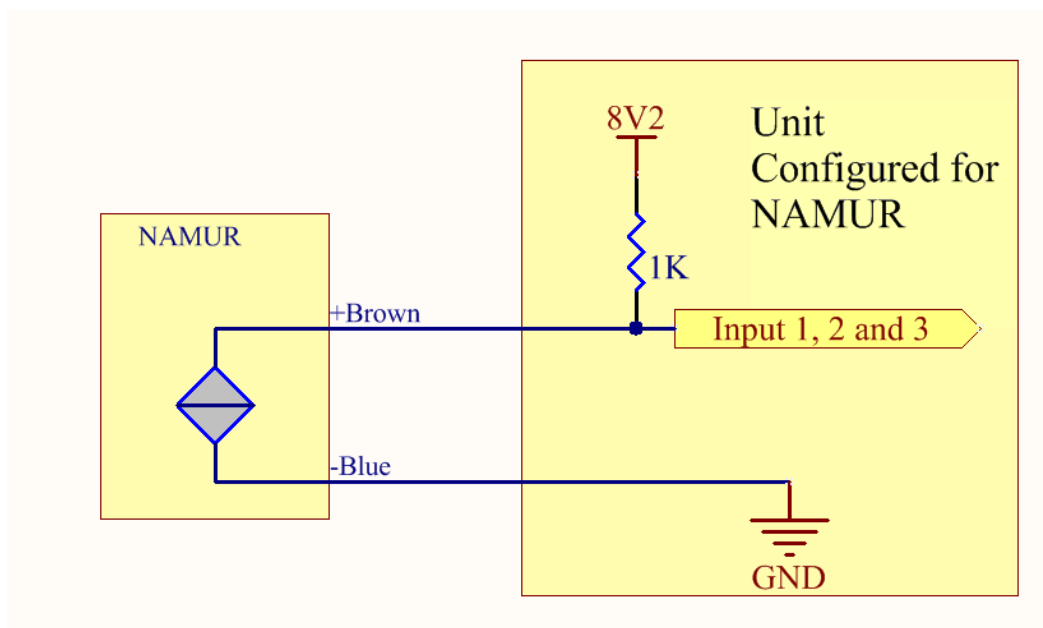

Analogue Sensor with Voltage output

There are various analogue sensors that connect directly to the unit which can provide a voltage output. These would require an external power source which may or may not be the same as the unit itself. The voltage range they provide can be between 0V and 30V. Some common sensor output ranges include 0V to 10V. These would work on the unit, The pull up resistor is not activated in this case.

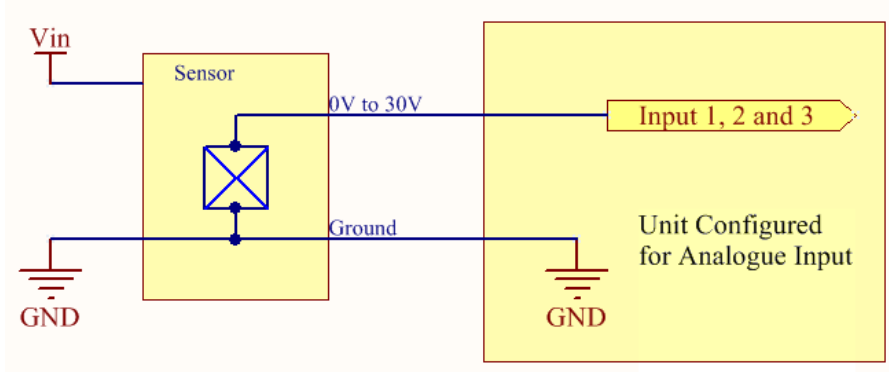

Analogue Sensor with 4 to 20mA output

Another common type of sensor type is the 4-20mA current loop sensor. It provides a known current through a fixed resistor, usually 250 ohms thus producing a voltage of 0v to 5v at the input. The sensor would require an external power source which may or may not be the same as the unit itself. It will also require an external resistor. The internal pull up resistor is not activated.

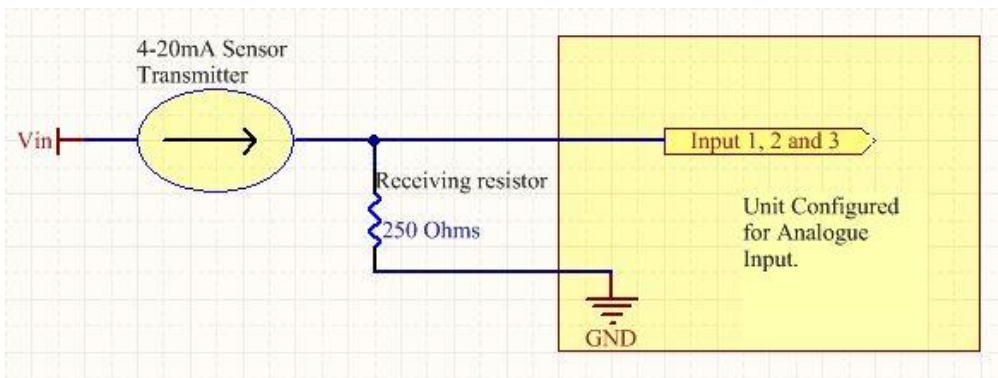

Analogue Sensor with Thermistor

Some sensors work by changing resistance due to a change, such as temperature, light etc. These may be wired up to an external or internal power source and the resistance can be read into the analogue signal. This will require some software calibration like scaling or offset to map the voltage received to the sensor resistor value. An example below shows the internal pull-up voltage and 1K resistor activated. The voltage received depends on the combination of resistors and the value of the resistance of the sensor itself.

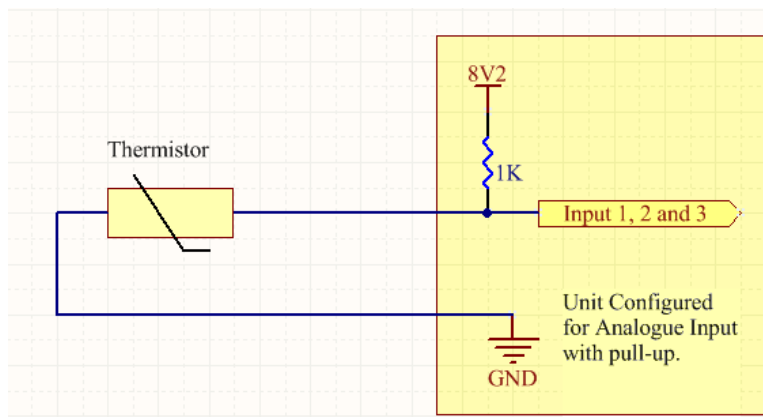

System Example –Solar powered Router with battery backup

The previous examples of wiring can be used to come up with a system. The following test case is an example of how the I/O's can be used to enhance a simple router setup.

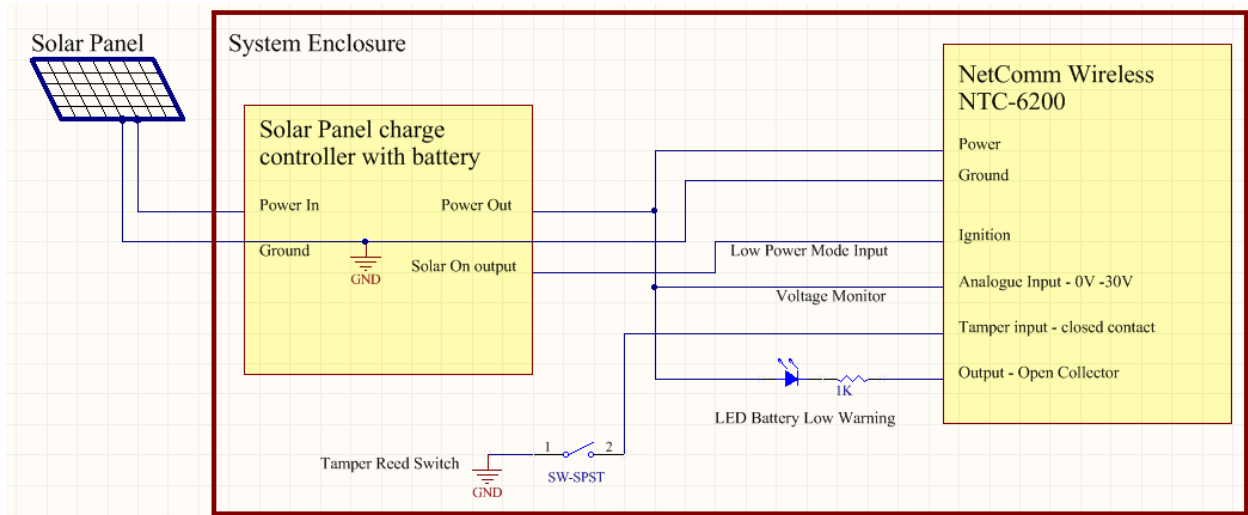

Appendix H: Obtaining a list of RDB variables

The RDB is a database of variables that contain settings on the router. You can retrieve (get) and set the values of these variables through the command-line or via SMS Diagnostics. To access a full list of the RDB variables, follow these steps:

1. Log in to the web user interface as described in the [Advanced configuration](#) section of this guide.
2. Click the **System** menu at the top of the screen, then select the **Administration** menu on the left. Finally, select the **Administration settings** menu item.
3. Click the **Enable Telnet** toggle key so that it is in the **ON** position.



4. Under the **Telnet/SSH account** section, enter a telnet password and then re-enter it in the **Confirm password** field.
5. Click the **Save** button at the bottom of the screen.
6. Open a terminal client such as PuTTY and telnet to the router using its IP address.

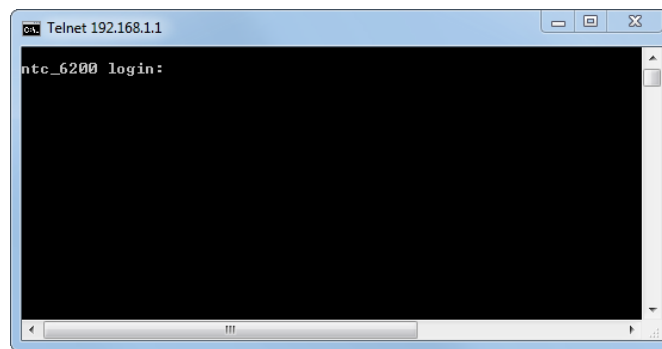

7. At the login prompt, type `root` and press Enter. At the password prompt, enter the password that you configured in step 4.
8. At the root prompt, enter the command `rdb dump | more`. This will display a list of every rdb variable on the router one page at a time.

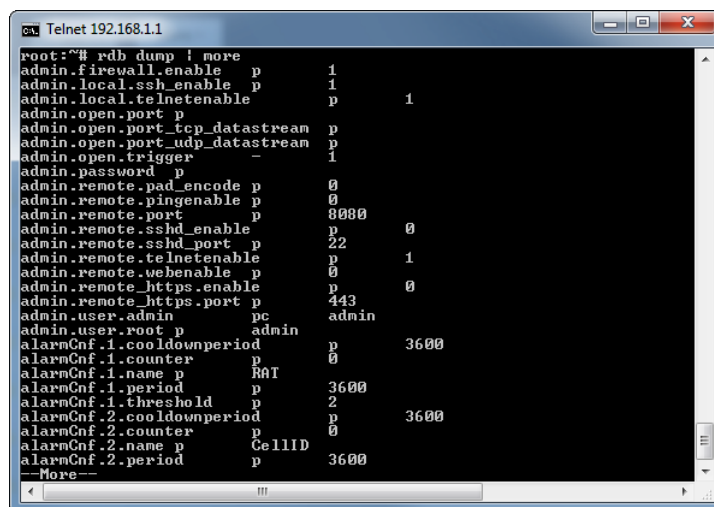

Note: Omitting the `| more` parameter will dump a complete list without pagination. For easier access, some terminal clients such as PuTTY have the ability to log all telnet output to a text file.

Safety and product care

RF Exposure

Your device contains a transmitter and a receiver. When it is on, it receives and transmits RF energy. When you communicate with your device, the system handling your connection controls the power level at which your device transmits.

This device meets the government's requirements for exposure to radio waves.

This device is designed and manufactured not to exceed the emission limits for exposure to radio frequency (RF) energy set by the Federal Communications Commission of the U.S. Government.

This equipment complies with radio frequency (RF) exposure limits adopted by the Federal Communications Commission for an uncontrolled environment. This equipment should be installed and operated with minimum distance 20 cm between the radiator & your body.

Déclaration d'exposition aux radiations:

Cet équipement est conforme aux limites d'exposition aux rayonnements IC établies pour un environnement non contrôlé. Cet équipement doit être installé et utilisé avec un minimum de 20 cm de distance entre la source de rayonnement et votre corps.

Tout gain d'antenne externe doit répondre l'exposition aux radiofréquences et les limites de puissance de sortie maximum rayonnée de la section de la règle applicable. Le gain maximal de l'antenne de cet appareil est: 1dBi (850MHz) et 1dBi (1900MHz).

External antenna

Any optional external antenna used for this transmitter must be installed to provide a separation distance of at least 20 cm from all persons and must not be co-located or operated in conjunction with any other antenna or transmitter. Please consult the health and safety guide of the chosen antenna for specific body separation guidelines as a greater distance of separation may be required for high-gain antennas.

Any external antenna gain must meet RF exposure and maximum radiated output power limits of the applicable rule section. The maximum antenna gain for this device as reported to the FCC is: 0.2 dBi (850MHz) and 2.7 dBi (1900MHz).

CE Approval

This device has been tested to and conforms to the regulatory requirements of the European Union and attained CE Marking. The CE Mark is a conformity marking consisting of the letters "CE." The CE Mark applies to the products regulated by the central European health, safety and environmental protection legislation. The CE Mark is obligatory for products it applies to: the manufacturer affixes the marking in order to be allowed to sell their product in the European market.

The wireless device is approved to be used in the member states of the EU. NetComm Wireless declares that the wireless device is in compliance with the essential requirements and other relevant provisions of the Radio and Telecommunications Terminal Equipment Directive 1999/5/EC (R&TTE Directive). Compliance with this directive implies conformity to the following European Norms – N 60950 – Product Safety, EN 301 489 EMC, EN301511 GSM RF, EN301908 UMTS RF, EN 62311 SAR Technical requirement for radio equipment. A notified body has determined that this device has properly demonstrated that the requirements of the directive have been met and has issued a favourable certificate of expert opinion. As such the device will bear the notified body number 0682 after the CE mark.

The CE Marking is not a quality mark. Foremost, it refers to the safety rather than to the quality of the product. Secondly, CE Marking is mandatory for the product it applies to whereas most quality markings are voluntary.

Marking: The product shall bear the CE mark, the notified body number(s) as depicted to the right. **CE 0682**

This product has also passed the following certification standards –

Health (Article 3.1(a) of the R&TTE Directive)

 EN 62311: 2008 ; EN 50385 :2002

Safety (Article 3.1(a) of the R&TTE Directive)

 EN 60950-1:2006/A11:2009+A1:2010+A12:2011

Electromagnetic compatibility (Article 3.1 (b) of the R&TTE Directive)

- 📶 EN 301 489-1 V1.9.2, EN 301 489-3 V1.4.1, EN 301 489-7 V1.3.1
- 📶 EN 301 489-17 V2.2.1
- 📶 EN 301 489-24 V1.5.1
- 📶 EN 55022:2010/ AC:2011 Class B, EN55024: 2010
- 📶 EN 61000-3-2:2006/A1:2009/A2:2009, EN 61000-3-3:2008

Radio frequency spectrum usage (Article 3.2 of the R&TTE Directive)

- 📶 EN 301 511 V9.0.2, EN 301 908-1 V5.2.1, EN 301 908-2 V5.2.1
- 📶 EN 300 328 V1.8.1
- 📶 EN 300 440-1 V1.6.1, EN 300 440-2 V1.4.1

RoHS Directive (2011/65/EU)

- 📶 EN 50581: 2012

NOTE: To comply with the RF exposure requirements, this equipment must be operated with a minimum of 20 cm separation from the user.

This is a regulatory requirement and applies to all 3G capable devices meeting standard regulatory compliance such as the compliance standards listed above.

FCC Statement

FCC compliance

Federal Communications Commission Notice (United States): Before a wireless device model is available for sale to the public, it must be tested and certified to the FCC that it does not exceed the limit established by the government-adopted requirement for safe exposure.

FCC regulations

This device complies with part 15 of the FCC Rules. Operation is subject to the following two conditions: (1) This device may not cause harmful interference, and (2) this device must accept any interference received, including interference that may cause undesired operation.

This device has been tested and found to comply with the limits for a Class B digital device, pursuant to Part 15 of the FCC Rules. These limits are designed to provide reasonable protection against harmful interference in a residential installation. This equipment generates, uses and can radiate radio frequency energy and, if not installed and used in accordance with the instructions, may cause harmful interference to radio communications. However, there is no guarantee that interference will not occur in a particular installation. If this equipment does cause harmful interference to radio or television reception, which can be determined by turning the equipment off and on, the user is encouraged to try to correct the interference by one or more of the following measures:

- 📶 Reorientate or relocate the receiving antenna.
- 📶 Increase the separation between the equipment and receiver.
- 📶 Connect the equipment into an outlet on a circuit different from that to which the receiver is connected.
- 📶 Consult the dealer or an experienced radio/TV technician for help.

Changes or modifications not expressly approved by the party responsible for compliance could void the user's authority to operate the equipment.

IC regulations

CAN ICES-3(B)/NMB-3(B)

This device complies with Industry Canada licence-exempt RSS standard(s). Operation is subject to the following two conditions:

- (1) this device may not cause interference, and
- (2) this device must accept any interference, including interference that may cause undesired operation of the device.

Le présent appareil est conforme aux CNR d'Industrie Canada applicables aux appareils radio exempts de licence. L'exploitation est autorisée aux deux conditions suivantes:

- (1) l'appareil ne doit pas produire de brouillage, et

(2) l'utilisateur de l'appareil doit accepter tout brouillage radioélectrique subi, même si le brouillage est susceptible d'en compromettre le fonctionnement."

This Class B digital apparatus complies with Canadian CAN ICES-3 (B)/NMB-3(B).

Cet appareil numérique de la classe B est conforme à la norme NMB-003 du Canada.

IMPORTANT NOTE:

IC radiation exposure statement:

This equipment complies with IC RSS-102 radiation exposure limits set forth for an uncontrolled environment. This equipment should be installed and operated with minimum distance 20cm between the radiator and users body.

Electrical safety

Accessories

Only use approved accessories.

Do not connect with incompatible products or accessories.

Connection to a car

Seek professional advice when connecting a device interface to the vehicle electrical system.

Distraction

Operating machinery

Full attention must be given to operating the machinery in order to reduce the risk of an accident.

Product handling

You alone are responsible for how you use your device and any consequences of its use.

You must always switch off your device wherever the use of a mobile phone is prohibited. Do not use the device without the clip-on covers attached, and do not remove or change the covers while using the device. Use of your device is subject to safety measures designed to protect users and their environment.

Always treat your device and its accessories with care and keep it in a clean and dust-free place.

Do not expose your device or its accessories to open flames or lit tobacco products.

Do not expose your device or its accessories to liquid, moisture or high humidity.

Do not drop, throw or try to bend your device or its accessories.

Do not use harsh chemicals, cleaning solvents, or aerosols to clean the device or its accessories.

Do not paint your device or its accessories.

Do not attempt to disassemble your device or its accessories, only authorised personnel must do so.

Do not use or install this product in extremely hot or cold areas. Ensure that the device is installed in an area where the temperature is within the supported operating temperature range (-20°C to 70°C).

Do not use or install this product outside of the supported altitude range (Sea level to 2,000 metres).

Do not use your device in an enclosed environment or where heat dissipation is poor. Prolonged use in such space may cause excessive heat and raise ambient temperature, which will lead to automatic shutdown of your device or the disconnection of the mobile network connection for your safety. To use your device normally again after such shutdown, cool it in a well-ventilated place before turning it on.

Please check local regulations for disposal of electronic products.

Do not operate the device where ventilation is restricted

Installation and configuration should be performed by trained personnel only.

Do not use or install this product near water to avoid fire or shock hazard. Avoid exposing the equipment to rain or damp areas.

Arrange power and Ethernet cables in a manner such that they are not likely to be stepped on or have items placed on them.

Ensure that the voltage and rated current of the power source match the requirements of the device. Do not connect the device to an inappropriate power source.

Small children

Do not leave your device and its accessories within the reach of small children or allow them to play with it.

They could hurt themselves or others, or could accidentally damage the device.

Your device contains small parts with sharp edges that may cause an injury or which could become detached and create a choking hazard.

Emergency & other situations requiring continuous connectivity

This device, like any wireless device, operates using radio signals, which cannot guarantee connection in all conditions. Therefore, you must never rely solely on any wireless device for emergency communications or otherwise use the device in situations where the interruption of data connectivity could lead to death, personal injury, property damage, data loss, or other loss.

Device heating

Your device may become warm during normal use.

Faulty and damaged products

Do not attempt to disassemble the device or its accessories.

Only qualified personnel must service or repair the device or its accessories.

If your device or its accessories have been submerged in water punctured or subjected to a severe fall, do not use until they have been checked at an authorised service centre.

Interference

Care must be taken when using the device in close proximity to personal medical devices, such as pacemakers and hearing aids.

Pacemakers

Pacemaker manufacturers recommend that a minimum separation of 15cm be maintained between a device and a pacemaker to avoid potential interference with the pacemaker.

Hearing aids

People with hearing aids or other cochlear implants may experience interfering noises when using wireless devices or when one is nearby.

The level of interference will depend on the type of hearing device and the distance from the interference source, increasing the separation between them may reduce the interference. You may also consult your hearing aid manufacturer to discuss alternatives.

Medical devices

Please consult your doctor and the device manufacturer to determine if operation of your device may interfere with the operation of your medical device.

Hospitals

Switch off your wireless device when requested to do so in hospitals, clinics or health care facilities. These requests are designed to prevent possible interference with sensitive medical equipment.

Interference in cars

Please note that because of possible interference to electronic equipment, some vehicle manufacturers forbid the use of devices in their vehicles unless an external antenna is included in the installation.

Explosive environments

Petrol stations and explosive atmospheres

In locations with potentially explosive atmospheres, obey all posted signs to turn off wireless devices such as your device or other radio equipment.

Areas with potentially explosive atmospheres include fuelling areas, below decks on boats, fuel or chemical transfer or storage facilities, areas where the air contains chemicals or particles, such as grain, dust, or metal powders.

Blasting caps and areas

Turn off your device or wireless device when in a blasting area or in areas posted turn off “two-way radios” or “electronic devices” to avoid interfering with blasting operations.

IDA Standards

The NTC-6200-02 complies with IDA Standards DA103787.

Complies with
IDA Standards
DA103787

Vietnam Certification

The NTC-6200-02 complies with QCVN 15: 2010/BTTTT.



Product Warranty

For warranty information please visit

<http://www.netcommwireless.com/product/m2m/ntc-6200>